

May 2018

# Optimal Decision Making for Capacitated Reverse Logistics Networks with Quality Variations

Sajjad Farahani

*University of Wisconsin-Milwaukee*

Follow this and additional works at: <https://dc.uwm.edu/etd>

 Part of the [Industrial Engineering Commons](#)

---

## Recommended Citation

Farahani, Sajjad, "Optimal Decision Making for Capacitated Reverse Logistics Networks with Quality Variations" (2018). *Theses and Dissertations*. 1796.

<https://dc.uwm.edu/etd/1796>

This Dissertation is brought to you for free and open access by UWM Digital Commons. It has been accepted for inclusion in Theses and Dissertations by an authorized administrator of UWM Digital Commons. For more information, please contact [open-access@uwm.edu](mailto:open-access@uwm.edu).

# OPTIMAL DECISION MAKING FOR CAPACITATED REVERSE LOGISTICS NETWORKS WITH QUALITY VARIATIONS

by

Sajjad Farahani

A Dissertation Submitted in  
Partial Fulfillment of the  
Requirements for the Degree of

Doctor of Philosophy  
in Engineering

at

The University of Wisconsin–Milwaukee

May 2018

## ABSTRACT

# OPTIMAL DECISION MAKING FOR CAPACITATED REVERSE LOGISTICS NETWORKS WITH QUALITY VARIATIONS

by

Sajjad Farahani

The University of Wisconsin–Milwaukee, 2018  
Under the Supervision of Professor Wilkistar Otieno

Increasing concerns about the environmental impact of production, product take-back laws and dwindling natural resources have heightened the need to address the impact of disposing end-of-life (EOL) products. To cope this challenge, manufacturers have integrated reverse logistics into their supply chain or chosen to outsource product recovery activities to third party firms. The uncertain quality of returns as well as uncertainty in return flow limit the effectiveness of planning, control and monitoring of reverse logistics networks. In addition, there are different recovery routes for each returned product such as reuse, repair, disassembling, remanufacturing and recycling. To determine the most profitable option for EOL product management, remanufacturers must consider the quality of returns and other limitations such as inventory size, demand and quantity of returns. The work in this dissertation addresses these pertinent aspects using two models that have been motivated by two remanufacturing facilities whereby there are uncertainties in the quality and quantity of return and capacitated inventories.

In the first case, a disposition decision making model is developed for a remanufacturing process in which the inventory capacity of recoverable returns is limited and where there's a constant demand to be met, for remanufactured products that meet a minimum quality threshold. It is assumed that the quality of returns is uncertain and remanufacturing cost is dependent on the quality grade. In this model, remanufacturing takes place when there is demand for remanufactured products. Accepted returns that meet the minimum quality threshold undergo the remanufacturing processes, and any unacceptable returns

are salvaged. A continuous time Markov chain (CTMC) is presented as the modeling approach. The Matrix-Geometric solution methodology is applied to evaluate several key performance metrics for this system, to result in the optimal disposition policy. The numerical study shows an intricate trade-off between the acceptable quality threshold value and the recoverable product inventory capacity. Particularly, there are periodic system starvation whenever there is a mis-match between these two system metrics. In addition, the sensitivity analysis indicates that changes to the demand rate for remanufactured products necessitates the need to re-evaluate the existing system configuration.

In the second case, a general framework is presented for a third party remanufacturer, where the remanufacturer has the alternative of salvaging EOL products and supplying parts to external suppliers, or remanufacture the disassembled parts to 'as new' conditions. The remanufacturing processes of reusable products and parts is studied in the context of other process variables such as the cost and demand of remanufactured products and parts. The goal of this model is to determine the return quality thresholds for a multi-product, multi-period remanufacturing setting. The problem is formulated as a mixed integer non-linear programming (MINLP) problem, which involves a discretization technique that turns the problem into a quadratic mixed integer programming (QMIP) problem. Finally, a numerical analysis using a personal computer (PC) remanufacturing facility data is used to test the extent to which the minimum acceptance quality threshold is dependent on the inventory level capacities of the EOL product management sites, varying operational costs and the upper bound of disposal rate.

# TABLE OF CONTENTS

<b>1</b>	<b>Introduction</b>	<b>1</b>
1.1	Background concepts . . . . .	4
1.2	Uncertainty in reverse logistics Networks . . . . .	7
1.3	Quality of returned products in reverse logistics . . . . .	8
1.4	Research Objectives . . . . .	8
1.5	Outline of the Dissertation . . . . .	9
<b>2</b>	<b>The Optimal Disposition Policy for Remanufacturing Systems with Variable Quality Returns (A Case Study)</b>	<b>11</b>
2.1	Introduction . . . . .	11
2.2	Model motivation . . . . .	12
2.3	Literature review . . . . .	14
2.4	Problem description and notations . . . . .	19
2.4.1	Inspection stage for class differentiation . . . . .	22
2.4.2	The Markov chain . . . . .	24
2.4.3	Computation of Steady-State Probabilities . . . . .	25
2.4.4	Translating stationary probabilities into performance measures . . . . .	26
2.4.5	Queuing performance measures . . . . .	28
2.5	Optimization Problem . . . . .	31
2.5.1	Remanufacturing net revenue and salvage value . . . . .	33
2.6	Numerical Study . . . . .	35
2.6.1	Effect of recoverable product inventory Capacity . . . . .	36
2.6.2	Effect of revenue-quality curve . . . . .	37
2.6.3	Effect of remanufacturing facility efficiency . . . . .	37
2.6.4	Effect of demand rate (system load) . . . . .	41
2.6.5	Effect of remanufacturing facility capacity . . . . .	42
2.7	Conclusions . . . . .	42
<b>3</b>	<b>Environmentally Friendly Disposition Decisions for End-Of-Life Electrical and Electronic Products: The Case of Computer Remanufacture</b>	<b>45</b>
3.1	Introduction . . . . .	45
3.2	Literature review . . . . .	48
3.2.1	Inventory control and Production Planning in Remanufacturing Systems . . . . .	48
3.2.2	Implications of quality uncertainty in returns . . . . .	50
3.2.3	End-of-Life option decision modeling . . . . .	52
3.3	Background . . . . .	54
3.3.1	The importance of computer remanufacturing . . . . .	54
3.3.2	Computer remanufacturing process . . . . .	56
3.4	Problem definition and mathematical formulation . . . . .	58
3.4.1	Notations . . . . .	62
3.4.2	Optimization objective . . . . .	64
3.4.3	Constraints . . . . .	66

3.5	Numerical illustration of model application . . . . .	69
3.5.1	Case study . . . . .	69
3.5.2	Solution approach . . . . .	75
3.5.3	Solution analysis and implications . . . . .	76
3.5.4	Sensitivity analysis . . . . .	78
3.6	Conclusion . . . . .	80
<b>4</b>	<b>Research Contributions and Future Research</b>	<b>84</b>
4.1	Research Contributions . . . . .	84
4.2	Suggestions for Future Work . . . . .	86
	<b>Bibliography</b>	<b>88</b>
	<b>Curriculum Vitae</b>	<b>103</b>

## LIST OF FIGURES

1.1	A general form of forward/reverse logistics processes (Agrawal et al., 2015).	5
2.1	Basic disposition decision problem. . . . .	13
2.2	The remanufacturing system under consideration. . . . .	19
2.3	Disposition decision and flow of products. . . . .	23
2.4	State transition in a 2-dimensional Markov chain. . . . .	24
2.5	Expected customer order completion delay, $E(D)$ . . . . .	29
2.6	Expected number of recoverable product in storage, $E(I)$ . . . . .	29
2.7	The expected number of rejected returned products following inspection, $E(P1)$ . . . . .	30
2.8	The expected number of returned product disposed when the storage is full, $E(P2)$ . . . . .	30
2.9	Remanufacturing net revenue curves $r(\omega)$ in \$, with respect to $SP = \$80$ , $a_0 = \$80$ , $a_1 = \$5$ . . . . .	34
2.10	The expected profit, revenue and cost versus different minimum required quality grade. . . . .	34
2.11	Impact of recoverable product inventory capacity on profit, revenue and cost. (a) profit functions, (b) revenue functions and (c) cost functions versus different minimum required quality grades for various $S$ . . . . .	38
2.12	Remanufacturing facility efficiency - quality curve. . . . .	40
2.13	$\omega^*(S)$ for various $S$ . . . . .	41
3.1	Computer recycling supply chain (Govindan and Popiuc, 2014) . . . . .	57
3.2	The remanufacturing system's conceptual framework, adopted from (Kim et al., 2006). . . . .	60
3.3	Different Quality levels following beta distribution using three parameter settings . . . . .	72
3.4	Acquisition price and remanufacturing cost of two different products for the numerical example. (a) shows the acquisition price vs. quality for 'PC 1', (b) shows the acquisition price vs. quality for 'PC 2', (c) shows the remanufacturing cost acquisition price vs. quality for 'PC 1' and (d) shows the remanufacturing cost acquisition price vs. quality for 'PC 2' . . . . .	74
3.5	Percentage of products go to remanufacturing and disassembly sites . . . . .	77
3.6	Optimal minimum quality for different quality levels for (a) 'PC 1' and 'PC 2' . . . . .	79
3.7	Effect of remanufacturing site capacity on profit . . . . .	80
3.8	Effect of disposal rate on disposal cost and profitability . . . . .	81

## LIST OF TABLES

1.1	EPR laws in other countries/regions (Kannan et al., 2017) . . . . .	2
2.2	Impact of minimum required quality grade on profit, revenue, cost and rejected returns . . . . .	35
2.3	Impact of recoverable inventory capacity . . . . .	37
2.4	Impact of net revenue-quality curve . . . . .	39
2.5	Optimal solution for various $\gamma$ and $\theta$ . . . . .	42
2.6	Optimal solution for various $\gamma$ , $\mu$ and $\theta$ . . . . .	43
3.1	The EOL options in PC recovery and the relevant alternatives . . . . .	56
3.2	Computer remanufacturing steps (Stats, 2015) . . . . .	58
3.6	Remanufacturing computer configuration example . . . . .	70
3.7	The number of parts for disassembling a single product $\rho_{pi}$ . . . . .	70
3.8	Returns forecast data for 6 months $\Phi_{pt}$ . . . . .	71
3.9	Estimates sales target for remanufactured product $p$ in period $t$ ( $\gamma_{pt}$ ) . . . . .	73
3.10	Required quantity of part $i$ in period $t$ ( $D_{it}$ ), cost of refurbishing(\$), capacity of refurbishing site and purchasing price(\$) of parts . . . . .	73
3.11	Optimal minimum quality and percentage of returns accepted for remanufacturing . . . . .	77
3.12	Number of rejected product $p$ in period $t$ and sent to disassembly site ( $g_{pt}^-$ ) . . . . .	77
3.13	Sales of remanufactured product $p$ in period $t$ to the secondary market ( $x_{pt}$ ) . . . . .	77
3.14	Number of refurbished part $i$ in period $t$ ( $\bar{q}_{it}$ ) . . . . .	77
3.15	Number of purchased part $i$ in period $t$ ( $y_{it}$ ) . . . . .	78



## ACKNOWLEDGEMENTS

This dissertation would not have been possible without the support and help of many, a few of whom it is possible to give particular mention.

I would like to express the deepest appreciation to my advisor, Professor Otieno, during my studies at University of Wisconsin-Milwaukee. She continually and convincingly conveyed a spirit of adventure in research, and excitement in teaching. Without her guidance and persistent help this dissertation would not have been possible.

I would also like to express my sincere gratitude to my committee members, Professor Hosseini, Professor Peters, Professor Seifoddini and Professor Yue for their valuable comments and insight.

I would like to acknowledge the financial and academic support of the Department of Industrial and Manufacturing Engineering, the College of Engineering and Applied Sciences, and the Graduate School at University of Wisconsin-Milwaukee. Specifically, the teaching assistantship appointments, graduate student and Chancellor awards gave me the necessary financial support during my academic pursuits at UWM. My special gratitude is extended to other professors in the Industrial and Manufacturing Engineering department Professor Campbell, Professor Jang and Professor Petering and also my former professors at Amrikabir University of Technology, Professor Seifi and Professor Akbarpour Shirazi for their supports in my graduate career.

Above all, and most importantly, I would like to express my very profound gratitude to my parents, who emphasized the value of education, guided me through life and served as my role models. Special thanks to them and my sisters for their continued love and encouragement, and providing me with unfailing support throughout my years of study and research. At the same time, I am grateful to my friends and other members of my family in Iran for their support, lasting interest and friendship even across geographical distances. This accomplishment would not have been possible without them.

---

# Chapter 1

## Introduction

Living in a world of finite resources and disposal capacities, the field of reverse logistics (RL) and product recovery continues to rise in importance, especially with the increasing environmental concerns, legislative pressures, various public policies and a global society that is aware and advocates for green and cleaner production. This is especially true, in this era that is plagued with overconsumption (Agrawal et al., 2015). Increasing resource conservation concerns and greater interest in waste reduction in industrialized countries led to the gradual replacement of a one-way perception of the production economy by strategies such as material cycle, End-Of-Life (OEL) product management, Reverse Logistics (RL) (Fleischmann et al., 1997) and recently, the Connected Supply Chain.

Furthermore, market evolution, changing customers expectations and civil education to minimize the environmental impacts of products and processes, have increased the need for Original Equipment Manufacturers (OEMs) and third party firms to consider customer-centric processes of product and material recovery (Gallo et al., 2009). Additionally, several countries have enforced laws aimed at changing the supply chain to ensure a more environmentally friendly or environmentally benign production sector.

End of Life (EOL) product management used to be the responsibility of the local (municipal) authorities before the Extended Producer Responsibility (EPR) legislature, among other governmental mandates, which currently hold the producers, importers and retailers responsible for appropriate recovery, recycling and disposal of EOL products (Li et al., 2014; Steubing et al., 2010).

The European Union (EU) directives on EOL product management, such as the paper recycling directive, EOL vehicle directive, and the Waste Electrical and Electronic Equipment (WEEE) directive, sets requirements on collection, recycling, and recovery of the respective goods and equipment from end users (Giri and Sharma, 2016). Various

Table 1.1: EPR laws in other countries/regions (Kannan et al., 2017)

EPR Law	Year	Country/State
Waste Management Act	1996	Ireland
Construction Material Recycling Law	2001	Japan
Waste Electrical and Electronic Equipment Directive	2003	Europe
End-of-Life Vehicle (ELV) Recycling Law	2003	Japan
Take Back Program for Electronic Devices	2008	West Virginia, USA
Computer Equipment Recovery	2008	Missouri, USA
Electronic Waste Prevention, Reuse and Recycling Act	2008	Rhode Island, USA
Action Plan for Extended Producer Responsibility	2009	Canada
Manufacturer Responsibility for Electronics	2010	Ireland
Electronic Equipment Reuse and Recycling Act	2010	South Carolina, USA
E-Waste (Management & Handling) Rules	2011	India
Recovery and Recycling of Televisions	2011	Texas, USA
Recycling Regulation	2011	British Columbia
EXPRA (Extended Producer Responsibility Alliance)	2013	Belgium

EPR laws are presented in Table 1.1.

Reverse logistics and product recovery are now considered a profitable and sustainable strategy for OEMs and Independent Third Party firms alike (Dekker et al., 2013; Guide Jr and Van Wassenhove, 2009). Some cases are largely known, for example, the remanufacture of single use cameras (Eastman Kodak and Fuji Film), toner cartridges (Xerox), photocopiers (Fuji Xerox, Australia, Netherlands and UK), commercial cleaning equipment (Electrolux), brand name computers (IBM, France, Germany, USA; HP, Australia) and power electronic drives (Rockwell Automation). These OEMs have obtained great advantages adopting such policies in improving their public image and profits (Franke et al., 2006).

In last decades, research on product recovery mainly focused on issues related to product design, engineering and marketing. Within this decade however, efforts have been made to research the feasibility of the logistical aspects of reuse, recycling, remanufacturing and disposal. Product recovery initiates additional material and information flow from primary end users (first customers) to producers and eventually the secondary market end users (Govindan et al., 2015).

Product recovery reduces the amount of waste disposal in landfills thus providing resource conservation by reusing some parts or using recovered materials instead of the virgin materials in the production of new or remanufactured products (Ahiska and Kurtul,

2014). Thus, product recovery has positive impacts on both the environment and the economy by reducing raw materials and energy usage, increasing jobs, increasing company profitability and improving the overall societal welfare (Rubio et al., 2008).

Remanufacturing is one of the most profitable EOL options, and is defined as the process of upgrading the quality of used products to 'like-new' condition (Galbreth and Blackburn, 2006; Guo and Ya, 2015). However, remanufacturing systems do have systemic challenges, including uncertainties in the quality, quantities, and the recovery time of the products, all of which add complexities to the reverse logistics in the remanufacturing business (Trebilcock, 2002).

This research provides solutions to facilitate decision making in reverse logistics networks with uncertainties in the demand, return quantity and quality. Such networks exist in a variety of remanufacturing industries as elucidated by (Lechner and Reimann, 2014).

Original Equipment Manufacturers (OEM) may decide to enter the recovery market of their own products, as a requirement following strict product take-back laws, voluntarily to increase their profitability, due to their customer needs or they may outsource recycling and/or remanufacturing to a third-party service provider. Any of these reasons require various product recovery activities such as product acquisition, disposition, remanufacturing process, and marketing, all of which result in several business, strategic and tactical decisions (Guide and Wassenhove, 2001).

In Section 1.1, we investigate some of the background concepts, looking closely at the definition of reverse logistics. Uncertainties in reverse logistics networks, particularly the uncertainty in the quality of returned products, and their effects on routing the returns. There are the two main unique aspects in decision making for reverse logistics addressed in this research. These two aspects are briefly discussed in Sections 1.2 and 1.3, which will lead into the objectives of this research.

## 1.1 Background concepts

Generally, the term Reverse Logistics is used in reference to a variety of processes. The following short background on the terminology illustrates that there is no agreed upon specific meaning, but all descriptions share a common thread of texts that imply the routing of used products from the end users back to an interested party.

In one of the first publications that defined Reverse Logistics described it as:

“ ... the movement of goods from a consumer towards a producer in a channel of distribution” (Pohlen and Theodore Farris, 1992).

Reverse Logistics was also defined by (Stock, 1992) in the early nineties as:

“ ...the term often used to refer to the role of logistics in recycling, waste disposal, and management of hazardous materials; a broader perspective includes all relating to logistics activities carried out in source reduction, recycling, substitution, reuse of materials and disposal.”

In another white paper published by the American Reverse Logistics Executive Council, Reverse Logistics is referred to as:

“The process of planning, implementing, and controlling the efficient, cost effective flow of raw materials, in-process inventory, finished goods and related information from the point of consumption to the point of origin for the purpose of recapturing value or proper disposal” (Tibben-Lembke and Rogers, 1998).

On the other hand, De Brito and Dekker (2002) defined Reverse Logistics as:

“... the process of planning, implementing and controlling backward flows of raw materials, in process inventory, packaging and finished goods, from a manufacturing, distribution or use point, to a point of recovery or point of proper disposal” (De Brito and Dekker, 2002).

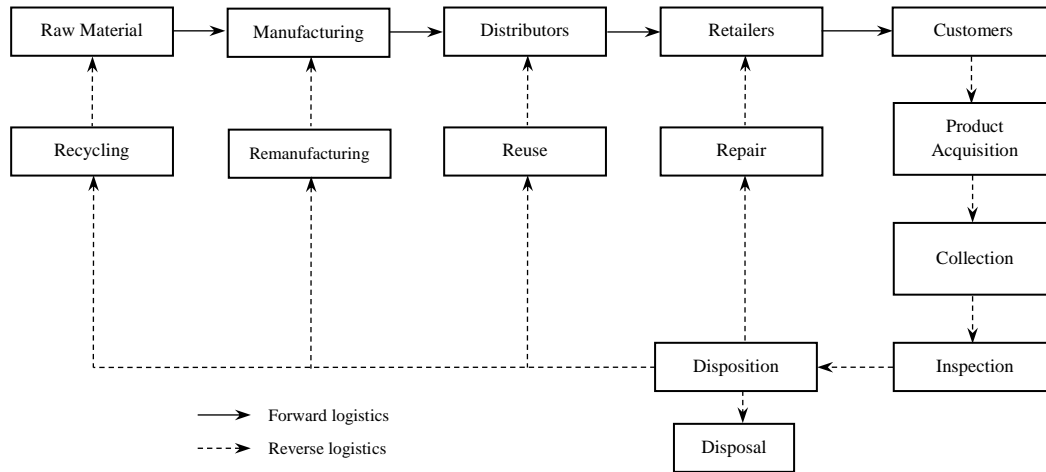

Figure 1.1: A general form of forward/reverse logistics processes (Agrawal et al., 2015).

More recently, Hawks (2006) defined Reverse Logistic as:

“... the process of moving goods from their typical final destination for the purpose of capturing value, or proper disposal. Remanufacturing and refurbishing activities also may be included in the definition of reverse logistics” (Hawks, 2006).

In addition to these definitions, Stock (1992) emphasized the role of reverse logistics in environmental management, and De Brito and Dekker (2002) highlighted the importance of value recovery in the Reverse Logistics, which differentiates the reverse logistics from the traditional disposal waste management.

According to American Reverse Logistics Executive Councils definition, reverse logistics deals with a variety of the necessary activities required to manage unwanted and returned products with the purpose of recovering their potential value while also safely and properly disposing what is not valuable. The key processes of reverse logistics are shown in Figure 1.1.

Used or unwanted products are acquired, collected and stored in collection centers. The collected products are thoroughly inspected and sorted into different categories. Next, the the sorted products go through processes such as repair, reuse, remanufacture, recycle or disposal. The appropriate decision for certain products highly depends on the quality or assigned category. The key processes are described as follows:

### 1. Product acquisition

The first step in reverse logistics is product acquisition which is acquiring the used or unwanted products, parts or materials from customers (Agrawal et al., 2015). In this step, the management could determine if reuse activities will be profitable considering the uncertainty in timing, quality and quantity of returns (Guide Jr et al., 2003). In some cases, the returned products may not be allowed into the system or will be sent back to the customers by retailers if the complaints are resolved. These set of practices are called gate keeping as a main entrance of the reverse logistics strategy (Agrawal et al., 2015).

### 2. Collection

Acquired products are collected and sent to the inspection and sorting facilities. The process of collection refers to a set of activities in which the products are physically moved from the customers to a point of recovery (De Brito and Dekker, 2002). There exist different methods of collection such as collecting directly from customers, collecting via retailers or through third parties (Kumar and Putnam 2008). According to Misni and Lee (2017), cost structure, collection quantity decision, flexibility, location, product complexity, and finally the reason that customer has returned the product are important factors in choosing the suitable collection method..

### 3. Inspection and sorting

In this step, the collected products are inspected, categorized and a decision is made on the required recovery process. Customers return the products at or before the end of life, hence the quality and conditions of returns vary widely because, in addition to the length of usage, customers have varying usage patterns. Therefore, it is necessary to inspect each return to properly decide the recovery path. The potential value of sorting and grading has been investigated by (Guide and Wassenhove, 2001; Aras et al., 2004; Galbreth and Blackburn, 2006; Zikopoulos and Tagaras, 2008).

#### 4. Disposition

After a product is inspected, depending on the quality of the returned product, different recovery activities such as reuse, repair, remanufacturing, recycling or even disposal can be applicable to a particular product. Low-quality returns could be recycled or disposed while high quality returned products could even be directly reused. Thierry et al. (1995); De Brito and Dekker (2002); Fleischmann et al. (1997); Pokharel and Mutha (2009) have discussed these disposition alternatives in depth. In some cases, cost to remanufacturing some returned products may be nearly as much as it would cost to manufacture a new product Omwando et al. (2018). This challenge makes disposition decisions a crucial issue and requires (re)manufacturers to determine the optima quality level that should be accepted into the remanufacturing process.

## 1.2 Uncertainty in reverse logistics Networks

The quality variation and non-uniform volumes of returns, difficulty in predicting the secondary market demand and processing or yield uncertainty are the main challenges that befall reverse logistics networks and thus should be addressed to make the process feasible (Fleischmann et al., 1997; Niknejad and Petrovic, 2014).

In contrast to forward networks, the uncertainties present in reverse logistics networks are higher and thus must be considered in any reverse logistics model to mitigate the negative consequences as much as possible. For instance, uncertainty in return quantities requires higher safety stocks of returned products or remanufactured products to avoid shortages. Note that an increase in remanufacturing cost by accepting returned products with lower quality grades or an increase in stock will increase the cost of recovery and in some cases, can even make recovery activities uneconomical.



### 1.3 Quality of returned products in reverse logistics

In forward routing, there is always a pre-determined precise quality expectation and so with manufacturing process, product quality ideally remain standard. To the contrary, in the reverse route, there is no certainty in quality consistency of the used products. The return quality varies highly, ranging from minor blemishes to significant damages, which have an impact on the remanufacturing cost and resale price (Nikolaidis, 2013; Ferguson et al., 2009). Also, quality considerations are important in reverse logistics process design. Particularly, quality of returns affect acquisition and remanufacturing decisions (Teunter and Flapper, 2011).

The returns may undergo different recovery processes such as reuse, repair, remanufacturing, recycling or even disposal on the basis of their quality, as determined in inspection and sorting stage. Products with low quality may be disposed or recycled for material recovery while the products with high quality could be remanufactured or even reused (Dobos and Richter, 2006; Das and Chowdhury, 2012). As a result, quality of returns is often the attribute that is mostly focused on when optimizing the remanufacturing processes. Although, within the past decade, reverse logistics or more specifically remanufacturing, has started to gain considerable attention; we discovered that few researchers or practitioners consider differential quality of returned products in their analysis. The main goal of this study therefore, is to model two existing remanufacturing environments with the objective of optimizing managerial decisions based on quality of returns and facility capacities. Though the models are informed by case facilities, they are general enough for application to other firms that deal with quality and inventory-driven remanufacturing processes.

### 1.4 Research Objectives

This research is focused on understanding the relationship and potential trade-offs between the quality of returns, uncertainty of the recovery process, and facility capacities and costs when making product disposition decisions for the reverse logistic network.

With this in mind, the following is a summary of this dissertation's research objectives.

- **Objective 1:** To model the disposition decision for a remanufacturer in a capacitated remanufacturing facility where the returns have diverse quality grades. Particularly, we look at the effect of a finite recoverable products inventory capacity and the quality grading system on the disposition decision where returns are inspected and triaged into two categories depending on whether they meet the set quality threshold. The developed model results in dynamic optimal quality threshold values for a certain inventory capacities.
- **Objective 2:** To develop a generalized model framework for third party remanufacturers with return quality decisions in the context of three different routes for the returned products or disassembled parts. A mixed integer non-linear programming model is used for the integrated production planning to determine the optimum minimum required quality grade to accept into the remanufacturing facility and the quantity of parts to purchase from external suppliers to maximize profits.

## 1.5 Outline of the Dissertation

In Chapter 2, an analytical queueing model is developed to find the optimal minimum acceptance quality grade for the product returns and the corresponding optimum inventory capacity for recoverable products. The remanufacturing system under this section of the study is formulated as a continuous time Markov chain. The dynamic process of the system is modeled as a Quasi-Birth-Death (QBD) process by rearranging the original state transition matrix. The Matrix-Geometric method is applied to find out how the system reacts via a basic queueing perspective. Further, we analyze several key performance measures of the remanufacturing-to-order system. The modeling technique and solutions provide important managerial insights for such a systems' performance under varying quality admission grades, thus providing better decision guidance for managing random quality of product returns. This chapter is based on a paper submission titled: "The Optimal Disposition Policy for Remanufacturing Systems with Variable Quality

Returns (A Case Study)”, by Farahani, S., Otieno, W., Omwando, T.

In Chapter 3, we propose the quality grading method and disposition decision for the returned products. Further, we develop a general framework for the considered third party remanufacturer with return quality decision. The integrated production planning for this remanufacturer is modeled as a mixed integer non-linear program to determine the optimum minimum required quality grade to accept into the remanufacturing facility and quantity of parts to purchase from external suppliers in to maximize the profit. In this chapter, several important aspects that prior works haven't addressed are incorporated collectively. They include: the acquisition price of the return, the remanufacturing cost, inventory holding costs, non-uniform rate of returns, and capacity constraints in a multi-product, multi-period production planning, which reflect real-world concerns of remanufacturing firms. Different routes for each returned product or disassembled parts are considered in the model. This chapter is based on a paper submission titled: "Environmentally Friendly Disposition Decisions for End-Of-Life Electrical and Electronic Products: The Case of Computer Remanufacture", by Farahani, S. , Otieno, W. A. , Barah, M.

Finally, Chapter 4 contains the overall conclusion and contributions of this research, in addition to the proposed directions for future studies.

---

## Chapter 2

# The Optimal Disposition Policy for Remanufacturing Systems with Variable Quality Returns (A Case Study)

## 2.1 Introduction

There has been a renewal of interest to utilize reverse logistics and product recovery as value added activities and sustainable strategies for enterprises all over the globe (Ahiska and Kurtul, 2014; Dekker et al., 2013). Due to governmental regulation, consumers' inclination toward green supply chains and possible economic benefits, an increasing number of companies have integrated product recovery activities into their processes (Ilgin and Gupta, 2010). Remanufacturing is one of the product recovery options which subsumes disassembling, cleaning, refurbishing, and replacing defective parts to restore them to like-new condition for remarketing, normally with similar warranty levels as new products(Thierry et al., 1995).

Remanufactured products are also referred to as refurbished, reconditioned, and re-certified, among other names (Abbey et al., 2017). Remanufacturing practices offer potential profits by recovering value from returns across variety of industries are embracing remanufacturing in their businesses. Currently, remanufacturing has reached nearly 300 billion dollars in annual returns in the United States alone (Abbey et al., 2017; Galbreth and Blackburn, 2006). These high returns notwithstanding, remanufacturing system still have challenges including diverse quality of returned products, inadequate reverse logistics infrastructure, processing or yield uncertainty, among others, which add complexities to the reverse logistics in remanufacturing business and make cost-effective demand fulfillment difficult (Guide, 2000; Trebilcock, 2002). Remanufacturing operations highly

depend on the quality grade of the returned product, which is the focus of this chapter. The quality of returned products and materials required for remanufacturing can vary widely because, in addition to the length of usage, customers have varying usage patterns. The price charged for remanufacturing units is often a function of returned product quality. Hence, the remanufacturing process requires a trade-off between quality and the associated cost of remanufacture(Ferguson et al., 2009).

In this chapter, we address the disposition decision that a remanufacturer has to make for product returns in a remanufacturing facility where the returns have diverse quality grades. Particularly, we look at the effect of a finite inventory capacity for recoverable products and an established quality grading system in which returns are inspected and classified into two different classes. The model developed in this chapter derives optimal properties for the general remanufacturing facility with diverse quality grades of product returns and a limited recoverable products inventory capacity. The next section of this chapter provides a summary description of the industry scenario that motivates this study.

## 2.2 Model motivation

In this study, we address the disposition decision that a remanufacturer need to make regarding product returns to maximize profit. We motivate our analysis by describing the remanufacturing process in a real remanufacturing facility. The studied facility tends to have a liberal return policy, implying that products are returned for a variety of reasons from customers site in batches with varied levels of conditions. Once they arrive at the remanufacturing facility, they are sorted by type and categorized by quality grades. A go-no-go decision is made on the basis of their quality to either dispose, or remanufacture them immediately or later. Products that meet the minimum required quality grade are stored in recoverable product inventory and will be remanufactured to order, to meet the market demands. The rest of returns are sold at an assigned salvage value for recycling. The basic disposition decision problem is presented in Figure 2.1.

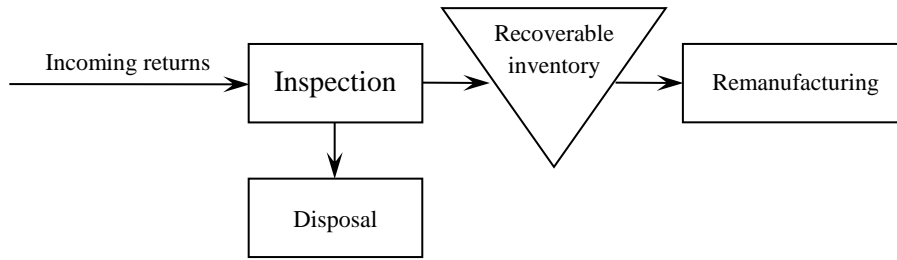

Figure 2.1: Basic disposition decision problem.

The modeled remanufacturing facility has a limited inventory capacity of recoverable returned products. Returned products arrive at the remanufacturing facility and are evaluated on a first come first served (FCFS) basis. The proposed model considers a stable demand for remanufactured products, with a reliable forecast. The modeled scenario depicts a remanufacture to order process which is typical for products with rapid technology (version) changes. In a survey results reported by Guide (1999), half of remanufacturers reported utilized a remanufacture to order, or a reassemble to order strategy. Similarly, another study by (Ferguson et al., 2009) indicates that generally, customers who purchase remanufactured products are drawn by the lower cost of remanufactured products compared to the cost of new products. However, the majority will only accept one generation behind the current available version. In the current practice, a unit from the returned products inventory is retrieved for processing after the remanufacturer has moved on to the following customers order. On the other hand, if there is no recoverable product available for remanufacture, the order remains queued until the next recoverable return arrives.

This study was motivated by the quest of the operation managers of the studied facility, to understand the remanufacturing cost ramifications associated with returned products quality grades and recoverable product inventory capacity. Hence, we include both trade-offs in a disposition decision model to maximize the profit of remanufacturing facility. The companys current policy is to salvage all returns when the full recoverable product inventory capacity has been reached. The quality grade of returns is not considered in the current basic disposition practice. Since quality can vary widely, so too can the cost of remanufacturing and its operations Guide et al. (2008).

An accepted returned product may not be restored to a pre-defined quality grade, especially if its initial quality level was below the threshold value. In practice, the efficiency of remanufacturing facility depends on factors such as product type, quality grade and congestion level at remanufacturing facility. In the studied case facility, about 10 percent of accepted returned product are not restored to the pre-defined quality grade and it costs the remanufacturer to discard products that do not meet required quality standards for resale.

The goal of this chapter is to model the existing industrial practice in order to optimize managerial decisions. Though the model is informed by the case facility, it is general enough that it can be applied to other firms that deal with quality and inventory-driven remanufacturing processes.

## 2.3 Literature review

Over the past decade, research on supply chain management has focused primarily on the recovery processes of end-of-life(EOL) products for refurbishing, recycling and remanufacturing. For a complete discussion of the related literature, see (Dekker et al., 2013; Ferrer and Whybark, 2003; Govindan et al., 2015; Srivastava, 2007).

Deterministic models are largely not suitable to depict real industrial scenarios that exhibit uncertainties in rate of returns, amount and quality grades of returns and the demand of remanufactured products. Given these aspects, queuing theory renders itself to be the appropriate tool for analyzing the status of remanufacturing processes. In this section, we refer to some of the studies that we recognize to be most related to this study.

Most prior research models such as those presented in (Fleischmann and Kuik, 2003; Karaer and Lee, 2007; Shi et al., 2011; Zhou et al., 2011) assumed that quantity of return independent from demand of remanufactured or manufactured products. Such an assumption is owed to the need to reduce model complexities (Kim et al., 2013; Vercaene and Gayon, 2013; Zerhouni et al., 2013). Kiesmüller and Van der Laan (2001) dealt with a remanufacturing system where the rate of core returns is demand-dependent

and Markov-chain approach was used to determine the optimal order-up-to policy for a finite planning horizon. Inderfurth and van der Laan (2001) developed a model where customer demand can be fulfilled either with newly produced products or remanufactured ones. In their article, the returned products are either accepted into the receiving inventory before transferring for remanufacturing, or disposed off. Mahadevan et al. (2003) studied a remanufacturing system where a used or rented/leased product is returned to the remanufacturing facility at the product's end of life and they proposed a pull and push inventory policy for this system.

Although, within the past decade, remanufacturing has been gaining considerable attention of both researchers and practitioners, the majority assume a heterogeneous quality grade for their returns (Ferguson et al., 2006; Golany et al., 2001; Van Der Laan et al., 1999; Van der Laan and Teunter, 2006; Toktay et al., 2000). In our findings, it was determined that a few researchers considered differential quality of returned products. Souza et al. (2002) studied a remanufacturing facility in which the returns were discretely categorized according to their quality grade. The authors modeled the system as an open multi-class queuing network and the optimal remanufacturing policy dedicate special remanufacturing stations for three quality levels (superior, average and inferior), under specified quality-based remanufacturing costs implications and quality-based processing time parameters to maximize the profits. Aras et al. (2004) developed a continuous time Markov chain (CTMC) model to show the advantage of quality-based classification of returns in a hybrid (re)manufacturing system. Galbreth and Blackburn (2006) modeled a remanufacturing system employing both deterministic and random demands. Their objective was to explore the feasibility of obtaining a threshold quality level that could be used to declare acceptable returns for remanufacture.

Dobos and Richter (2006) extended their previous Economic Order Quantity (EOQ) study reported in (Dobos and Richter, 2004) by considering returns quality variation in a model which involves a hybridized scenario whereby the demand can be fulfilled using new products, recycled products or a mix of both. Additionally, their model tests two collection strategies for the returned products. In the first strategy, all used products



are repurchased and only a proportion of them are reused to fulfill the demand. In the second strategy, a proportion of the used products that are deemed to be serviceable are bought back. They concluded that if only the inventory-related holding costs are included in the model, then all used products should be repurchased. On the other hand, when the EOQ and non-EOQ related costs are included in the model, then the second strategy is optimal, in which case the 'quality control' function is outsourced and only the serviceable used products are bought back.

Mitra (2007) analyzed a single period recovery network and claimed that different quality level would draw varying prices in the secondary market. Takahashi et al. (2007) proposed a remanufacturing system with a two-policy model where the recovered products are classified into either materials/parts to be used and waste parts to be disposed. They employed a Markov process analysis to assess the performance of the two policies. Mukhopadhyay and Ma (2009) proposed a stochastic model to study the impact of uncertain quality of returned products and market demand on optimal procurement and production decisions. Ferguson et al. (2009) proposed a master production planning method for a remanufacturing system in which returns quality grades are not the same. The goal of their research was to investigate the value of quality grading in which returned products are classified into a finite number of quality grades. El Saadany and Jaber (2010) presented a comparative analysis of various recycled products, and showed that their return rate is depended on the acceptance quality level and purchasing price of the returned items. Jin et al. (2011) studied the assembly processes in a remanufacturing system to find the optimized reassembly strategy with returns quantity, quality and timing variability.

The economic aspect of remanufacturing systems is considered by several researchers. Kumar and Ramachandran (2016) offered comprehensive reviews of revenue management in remanufacturing. Bayındır et al. (2003) modeled a remanufacturing system to investigate impact of costs related to the inventory on the profit margin. Geyer et al. (2007) inspired by Kodaks single-use camera, developed a model to maximize profit in the face of market demand uncertainty, limited product durability and limited product life cy-

cle. Zikopoulos and Tagaras (2007) examined the economic attractiveness of a sorting procedure that categorizes returns into remanufacturable or non-remanufacturable cores prior to disassembly. Harrison (1975) studied the admission control problem for a single server queuing system with linear cost function and assuming the salvage value is zero. Guide et al. (2008) extended Harrison's work by considering the positive salvage value and provided an analytical model to find the optimum disposition of returns considering the time value of returns. Their study found out that it is better to sell some of the returns as a result to decongest the facility.

Several remanufacturing-related research have adopted queuing theory to model a variety of performance analyses remanufacturing decision problems (Ilgin and Gupta, 2012), Toktay et al. (2000). Ching et al. (2003) proposed a simple Markovian inventory management model for a production systems with returns that are remanufactured to replenish the inventory. Ching et al. (2007) built a Markovian queuing model for hybrid manufacturing/remanufacturing systems and applied the matrix geometric method to analyze the resulting queuing network. Takahashi et al. (2007) proposed a variety of policies for controlling inventories of classified recovered products using a decomposition process. They used Markov chain analysis to investigate the performance of the proposed policies and to obtain the optimal one. Karamouzian et al. (2011) developed an analytical model using queuing network to determine the best strategy of accepting returns and Jin et al. (2014) considered a reassemble-to-order system with an admission control on returns. Their paper presents a quasi-birth-and-death (QBD) to evaluate the key performance measures of this system where the main source of returns are warranty claims. Ahiska and Kurtul (2014) formulated the periodic-review inventory control problem as a discrete-time Markov Decision Process (MDP), where new and remanufactured products have distinct market streams but can be substituted for each other to fulfill the stochastic demands. In their work, they found the profit of such a hybrid (re)manufacturing system is highly depended on the ratio of the price of a remanufactured product versus the cost to manufacture a new product. Fathi et al. (2015) presented queuing models for a disposition decision problem based on the required time to process the returned products in

a remanufacturing facility. Pasandideh et al. (2015) investigated a manufacturing facility consisting of workstations with limited capacity for remanufacturing returned products to find the optimum set capacities.

The above surveyed work, as many others in the literature, do not take into account the effect of delays in the remanufacturing facility caused by the interconnectedness of demand variability, cost of remanufacture and quality variability. In addition, in contrast to the most discussed models that assume that recovered products (repaired or remanufactured) are as-new ones, our study, similar to Ferguson et al. (2009) assumes that remanufactured products are not perfect substitutes of new ones. We have employed an inspection procedure that categorizes the returns into quality grades which inherently determine the cost of remanufacture and salvage value of the returns.

Another assumption in the models discussed in the this section is that the hybrid (re)manufacturing process is perfect. In any production system, resources may not be capable of remanufacturing products of the required quality level due to process and (or) product-related deficiencies (Giri and Sharma, 2015). In this study, we assume that the efficiency rate of the remanufacturing facility is depended on the quality of returned products. It means that a much greater proportion of products with lower quality will be discarded.

The model in this chapter mimics a scenario in which there is rapid change of technology, hence the remanufacturing process is order-driven. The main goal of this chapter is to provide an analytical queuing model to find the optimal minimum required quality grade of returns to accept for remanufacture and the optimum inventory capacity for recoverable products. Both of these process metrics are dynamic and are highly dependent on core returns and customer orders. We formulate a continuous time Markov chain in order to describe this remanufacturing system under study. The dynamic process of the system is modeled as a Quasi-Birth-Death (QBD) process by rearranging the original state transition matrix. Similar to (Jewkes and Alfa, 2009), the Matrix-Geometric method is applied to find out how the system acts via a basic queuing perspective.

A numerical analysis is also conducted on variety of remanufacturing systems' perfor-

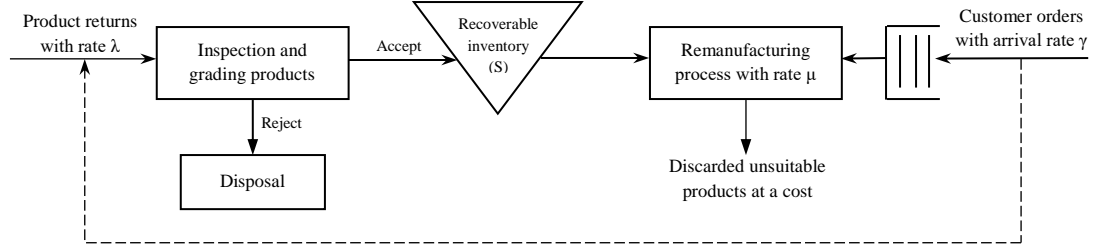

Figure 2.2: The remanufacturing system under consideration.

mance measures to evaluate the effect of admission threshold (quality) on the performance measures which include the inventory level, mean disposed products and customer order completion delay. Moreover, the numerical analyses also enable the analysis of the effect of quality grade on the remanufacturing facility efficiency and the return admission threshold.

## 2.4 Problem description and notations

We consider a limited capacity facility that remanufactures returned products for the remanufactured products market. The products returning from customer are tested for quality and kept in a storage named recoverable product inventory used to satisfy the stochastic demand. Figure 2.2 illustrates the proposed model.

The arrival of returned products is assumed to follow a Poisson process with mean rate  $\lambda$ . The inspection stage has an unlimited capacity. The storage, however, has a limited capacity of recoverable products. The model also assumes a multi-product system with a dedicated storage for each product type. Similar to Ferguson et al. (2009), the quality of returns is defined by a fuzzy set of real number denoted by  $\omega \in [0, 1]$ ; where  $\omega = 1$  means that returned product has highest quality grade and  $\omega = 0$  means total scrap. In remanufacturing process, the quality of returned products will be improved to highest grade to suit a customer order.

Rather than to discretize the quality into distinct categories that might obscure the systems dynamics, the model assumes that  $\omega$  is a continuous variable for a better insight into the impact of  $\omega$  on the system's KPIs. Modeling  $\omega$  as a continuous variable presents

a general case which can be easily be altered to mimic the discretized scenario.

As was indicated earlier, the quality grades of returned products is highly variable. The shape of quality grade probability distribution curve depends on many factors such as product characteristics, return time with respect to purchase time (when new), consumer usage, direct market and product reliability. Like Ferguson et al. (2009), the modeled facility has a known prior probability distribution of quality  $f(\omega)$ . Previous researchers have tested various distribution functions including the exponential, normal and beta distributions (Ferguson et al., 2009; Galbreth and Blackburn, 2006; Korugan et al., 2013). For the purpose of this study, the beta distribution is adopted as the  $\omega$  prior because of its ease of implementation in the solution methodology.

The products with minimum required quality grades will be accepted at the inspection stage and will be stored in recoverable products inventory, but as soon as the number of recoverable products in inventory reaches the capacity limit  $S$ , the inspection stage stops testing return arrivals and the remaining returned products are sold as-is until the number of waiting falls below  $S$ . The holding cost per unit of the recoverable products is denoted by  $C_h$ . The remanufacturing time of a recoverable product has an exponential distribution with parameter  $\mu$ . For modeling purposes, this study does not consider time variations in the remanufacturing process as a resulting from quality variations.

Customers' demand of the remanufactured products are assumed to arrive at a Poisson rate of  $\gamma$ , and served on a FCFS basis. A unit is removed from the recoverable product inventory and processed to the highest quality grade. If there is no recoverable product available, the order is back-logged until a new returned product arrives into the inventory. We make the assumption that there is no limit on the back-log queue. To avoid delays in satisfying customers order, the remanufacturer is forced to remanufacture returned products with lower quality grades, thus incurring additional costs denoted by  $C_d$ .

We assume that there is a probability  $\theta$  that an accepted returned product for remanufacturing will not be processed properly and therefore will not be suitable for resale. Consequently,  $\theta$  decreases monotonically with increasing  $\omega$ . The value of  $\theta$  can be thought of as a characteristic of the remanufacturing facility's efficiency too, which de-

depends on the product type, quality grade and congestion level at remanufacturing facility. Higher values of  $\theta$  indicate lower process efficiency which imply that a higher percentage of recoverable products will be discarded for salvaging during the remanufacturing. Conversely, lower values of  $\theta$  on the other hand, may be appropriate if the remanufacturing facility has higher efficiency rates thus higher percentage of recoverable products will be remanufactured properly. We assume that it costs the remanufacturer  $C_w$  to discard a recoverable product. Mathematically,  $\theta = 0.1$  indicates that 10% of recoverable products will not be restored to the predefined quality grade. More general forms are modeled in Section 2.6.3.

From the remanufacturer's view point, the lower the minimum required quality to accept returned products, or the lower minimum required quality grade  $\omega^*$ , the faster the response to customers' orders. However, as indicated before, low quality levels result in higher cost of remanufacture, in addition to the likelihood that a larger proportion may not be remanufactured to qualities that ensure customer satisfaction. While higher values of  $\omega^*$  imply reduced cost of remanufacture, they also imply increased order fulfilment time that may result from system starvation. In our studied facility, the remanufacturer wishes to have a service level goal that would prevent customer order completion delay. In so doing, creating a trade-off between the holding cost of recoverable products inventory, customer order completion delay, net revenue of selling remanufactured products and the allowable quality threshold  $\omega^*$ .

As it was pointed out earlier, the remanufacturing facility has a dedicated limited capacity storage for inspected recoverable products. The more the storage, the more equipped the remanufacturer is to respond to customer demand. However, more storage capacity comes with a higher holding cost, thus the remanufacturer needs to consider these factors when selecting the optimal inventory capacity. Therefore, the purpose of this study is to develop a model that can be used to examine the trade-offs made by the remanufacturer when selecting parameters  $S$  and  $\omega^*$ . Further details on the inspection stage and quality class differentiation are given in Section 2.4.1. The following is a list of notations that are used throughout this chapter:

*Notations and parameters:*

- $\mu$ : Rate of a single exponential remanufacturing server (units/unit time);
- $\lambda$ : Rate of product returns (units/unit time);
- $\gamma$ : Demand rate (units/unit time);
- $P(\omega)$ : Salvage value (dollars/unit);
- $C_h$ : Holding cost of returned products (dollars/unit);
- $C_w$ : Cost of discarding recoverable product during remanufacturing process (dollars/unit);
- $C_d$ : Cost of customer order completion delay (dollars/unit);
- $C_S$ : Cost of recoverable products inventory establishment (dollars/unit);
- $r(\omega)$ : Revenue from remanufacturing a returned product (dollars/unit);
- $E[M]$ : Expected number of remanufactured products (units/unit time);
- $E[P_1]$ : Expected count of rejected products that are disposed (units/unit time);
- $E[P_2]$ : Expected count of disposed products resulting from storage capacity limits (units/unit time);
- $E[I]$ : Expected number of stored recoverable products (units/unit time);
- $E[W]$ : Expected number of products discarded during the remanufacturing process (units/unit time);
- $E[D]$ : Expected customer order completion delay (units/unit time);
- $E[N]$ : Expected count of customers on the queue (units/unit time);
- $\omega^*$ : The required minimum quality level of returned products, ( $0 \leq \omega^* \leq 1$ );
- $S$ : Recoverable products inventory capacity (units)

### 2.4.1 Inspection stage for class differentiation

It is expected that there would be variability in the time, labor and materials required to remanufacture returns as discussed in (Otieno, 2015; Omwando et al., 2018). This

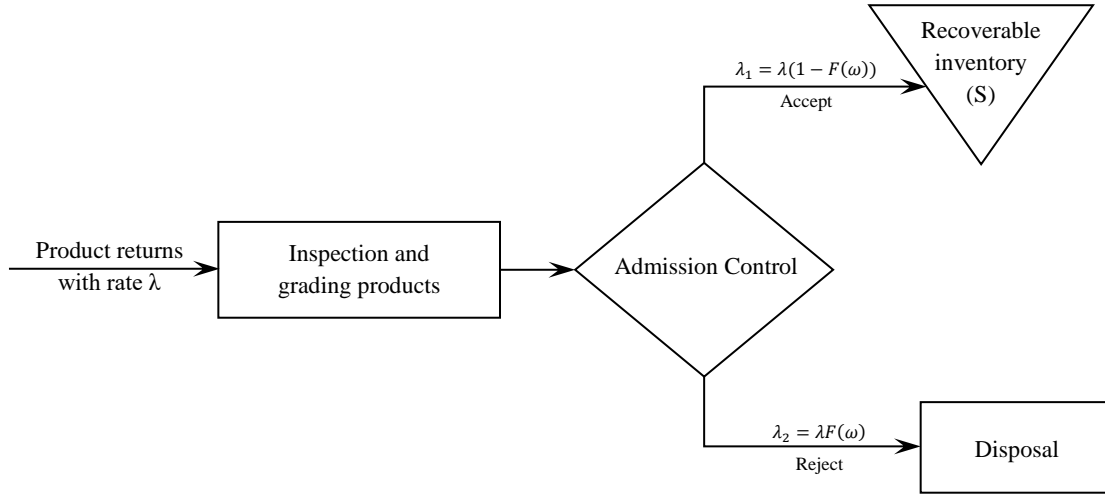

Figure 2.3: Disposition decision and flow of products.

chapter incorporates an inspection stage with an unlimited capacity to determine the returns condition and quality. All returns are drawn from the same distribution but at different rates. For all returned products within a product type, the quality grade is a random variable  $\omega$ , with a common distribution function (CDF)  $F(\omega)$ . In order to determine the admission decision, we need to find a threshold value (minimum required quality grade  $\omega^*$ ). All the returned products with a quality grade less than a threshold value are rejected from the remanufacturing system, while those within the estimated quality grade i.e. greater or equal to  $\omega^*$  are accepted for remanufacture.

Assuming that the arrival rate of returns is  $\lambda$ , the threshold value  $\omega^*$  classifies the returned products into two different classes as shown in Figure 2.3. *Class 1* of the returned products comprises products with a quality grade greater than  $\omega^*$  which are accepted to the remanufacturing process with arrival rate of  $\lambda_1 = \lambda(1 - F(\omega))$ . Products with a quality grade less or equal to  $\omega^*$  define *Class 2* of the returned products that are rejected (recycled) with arrival rate of  $\lambda_2 = \lambda(F(\omega))$  (Ferguson et al., 2009; Guide et al., 2008).  $\lambda_1$  is a random variable which has a truncated probability distribution given by  $f_1(\omega)/F(\omega^*)$  for  $\omega > \omega^*$  or 0 otherwise. The method that determines the optimal threshold quality grade  $\omega^*$  is developed in Section 2.4.2.



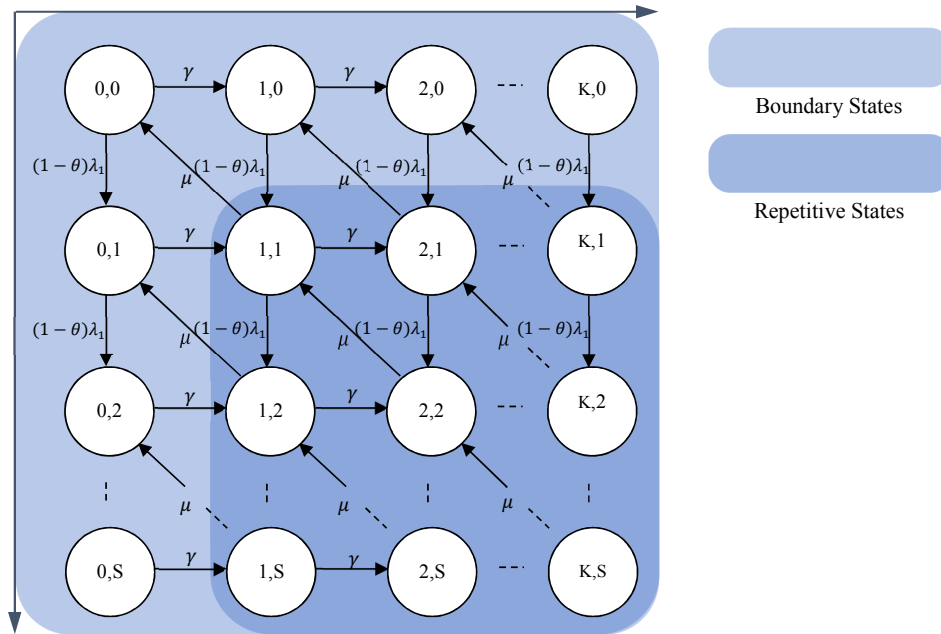

Figure 2.4: State transition in a 2-dimensional Markov chain.

## 2.4.2 The Markov chain

For the admission policy problem, the system is modeled as a quasi-birth-death process (QBD) which is characterized by a 2-tuple  $(x(t), y(t))$  time two-dimensional continuous Markov chain. Thus, the next system state only dependent on the current state only (not other past states). The system state space can be defined as:  $\{(x, y) : x = 0, 1, \dots, y = 0, 1, \dots, S\}$ , where  $x$  (the level of the process) represents the number of customer orders queued in the system and  $y$  (the phase of the process) is the number of recoverable products stored in the inventory waiting to be processed in the remanufacturing facility. The state transition diagram is shown in Figure 2.4, where all possible system states and rates of transition are illustrated.

The considered state space is finite and ergodic and so the system may reach a steady state, whose probability is denoted by  $\pi_{x,y}$ . The detail of the methodology used to obtain the stationary distribution of the Markov chain is presented in Section 2.4.3, while the system's performance measures are analyzed in Section 2.4.5.

### 2.4.3 Computation of Steady-State Probabilities

There exists different methods to solve a quasi-birth-and-death (QBD) model. For an overview, we refer the reader to (Latouche and Ramaswami, 1993; Van Leeuwen and Winands, 2006). The model discussed in this study can be written compactly in matrix form fitting the properties of the QBD process, which can be solved by the matrix geometric method that was initially presented by Neuts (1981) and has been used before to solve QBD process-oriented problems such as ours (Chang and Lu, 2010, 2008; Flapper et al., 2014; Jewkes and Alfa, 2009; Song et al., 1999).

The generator matrix  $\mathbf{Q}$  which is related to the Markov chain is derived in order to obtain the steady-state probability matrix as follows:

$$\mathbf{Q} = \begin{bmatrix} B_0 & A_0 & & & \\ & A_1 & A_0 & & \\ & A_2 & A_1 & A_0 & \\ & & \ddots & \ddots & \ddots \end{bmatrix},$$

where

$$\mathbf{B}_0 = \begin{bmatrix} -(\gamma + (1 - \theta)\lambda_1) & (1 - \theta)\lambda_1 & & & \\ & -(\gamma + (1 - \theta)\lambda_1) & (1 - \theta)\lambda_1 & & \\ & & \ddots & \ddots & \\ & & & -(\gamma + (1 - \theta)\lambda_1) & (1 - \theta)\lambda_1 \\ & & & & -\gamma \end{bmatrix},$$

$$\mathbf{A}_1 = \begin{bmatrix} -(\gamma + (1 - \theta)\lambda_1) & (1 - \theta)\lambda_1 & & & \\ & -(\gamma + (1 - \theta)\lambda_1 + \mu) & (1 - \theta)\lambda_1 & & \\ & & \ddots & \ddots & \\ & & & -(\gamma + (1 - \theta)\lambda_1 + \mu) & (1 - \theta)\lambda_1 \\ & & & & -(\gamma + \mu) \end{bmatrix},$$

$$\mathbf{A}_2 = \begin{bmatrix} \mu & & & \\ & \mu & & \\ & & \ddots & \\ & & & \mu \end{bmatrix}, \mathbf{A}_0 = \mathbf{I}\lambda,$$

For convenience, let the limiting probability vector  $\pi$ , which is partitioned as  $[\pi_0, \pi_1, \pi_2, \dots]$ , be a stationary distribution where

$$\pi \mathbf{1} = 1, \text{ and } \pi \mathbf{Q} = \mathbf{0}.$$

In this case,  $\mathbf{1}$  is a unit line-vector and  $\mathbf{0}$  is a null line-vector.

$\mathbf{R}$ , which is the steady-state probability matrix is used to show the matrix-geometric equation given by:

$$\pi_i + 1 = \pi_i \mathbf{R}, \quad i \geq 0$$

Next, the matrix quadratic is used to evaluate  $\mathbf{R}$  as follows:

$$\mathbf{A}_0 + \mathbf{R}\mathbf{A}_1 + \mathbf{R}^2\mathbf{A}_2 = \mathbf{0}$$

For stability and ergodicity reasons,

$$\pi \mathbf{A}_0 \mathbf{1} < \pi \mathbf{A}_2 \mathbf{1}$$

$\mathbf{R}$  can be calculated directly, iteratively or by logarithmic reduction (Bolch et al., 2006; Latouche and Ramaswami, 1999; Meini, 1998).  $\mathbf{R}$  is iteratively solved by the successive substitution approach given as:

$$\mathbf{R}_{(0)} = \mathbf{0}, \text{ and } \mathbf{R}_{(n+1)} = -(\mathbf{A}_0 + \mathbf{R}_{(n)}^2 \mathbf{A}_2) \mathbf{A}_1^{-1}$$

The iteration is stopped when  $\|\mathbf{R}_{(n+1)} - \mathbf{R}_{(n)}\| < \epsilon$ . The boundary vector  $\pi_0$  is obtained from  $\pi_0(\mathbf{B}_0 + \mathbf{R}\mathbf{A}_2) = \mathbf{0}$ . We then normalize it by  $\pi_0(\mathbf{I} - \mathbf{R})^{-1} \mathbf{1} = 1$ .

#### 2.4.4 Translating stationary probabilities into performance measures

In this section, we show how stationary probabilities are used to obtain several queuing performance measures of the remanufacturing facility model.

1. The mean customer completion delay:

We assume that customer's order arriving into the system will have an average completion delay of  $E[D]$ . The delay represents the average time customers spend in system. By using Little's Law, the average number of customer orders in the queue including the one in process is given by:

$$E[N] = \pi_1(\mathbf{I} - \mathbf{R})^{-2}$$

Thus, the mean customer order completion delay for a given demand arrival rate  $\gamma$ , is denoted by

$$E[D] = \frac{E[N]}{\gamma}.$$

2. The mean inventory of recoverable products:

The mean number of returned products accepted to remanufacture in the system is given by

$$E[I] = \pi_0(\mathbf{I} - \mathbf{R})^{-2}\mathbf{v},$$

Where  $\mathbf{v} = [0, 1, 2, \dots, S]^T$ .

3. Mean number of remanufactured and disposed returned products:

Returned products will be remanufactured when the quality grade of returned product is higher than threshold quality grade otherwise they will be disposed. Also, when the storage has reached its capacity limit all return arrival without being tested will be disposed off. Thus, given a mean arrival rate of accepted products for remanufacture (*Class 1*)  $\lambda_1$ , the expected number of finished products per unit time can be shown to be:  $E[M] = (1 - Pr(y = S))\lambda_1$ ,

where  $Pr(y = S)$  denotes the probability that recoverable product inventory has reached its capacity limit of  $S$ . Also for a mean arrival rate of rejected returned products (*Class 2*)  $\lambda_2$ , the expected number of rejected returned products in inspection stage that will be disposed is given as  $E[P_1] = (1 - Pr(y = S))\lambda_2$ ,

And the expected number of returned product disposed when the recoverable products inventory is full is given by  $E[P_2] = Pr(y = S)\lambda$

4. Expected discarded recoverable products:

The expected number of discarded products per unit time during is expressed as

$$E[W] = (1 - Pr(y = S))\theta\lambda_1$$

The Section 2.4.5 provides the initial computational results to illustrate how the system performance measures behave as a function of recoverable products inventory capacity and returns quality.

### 2.4.5 Queuing performance measures

To find out how the proposed admission policy behaves from a basic queuing perspective, this section presents some performance measures. The results are based on a MATLAB code where  $\omega$  was varied between 0.01 and 0.99 with intervals of 0.01. The results illustrate how computed performance measures relate to  $S$  and  $\omega^*$ . In the Figures 2.5-2.8, the basic parameters were held constant at  $\lambda = 1.25$ ,  $\mu = 1$  and  $\gamma = 0.75$ , and the quality of returns was allowed to follow a beta distribution with parameters  $\alpha$  and  $\beta$  of 5 and 2 respectively. Finally, we assume that  $\theta = 0.1$ , implying that 10% of returned product will not be recovered properly in remanufacturing facility and will be discarded. In Section 2.6.3, we discuss the relationship between  $\theta$  values, which represent the efficiency of remanufacturing facility with returns quality.

The Figures 2.5-2.8 give useful insights into the behavior of the admission control policy for use in the subsequent sections. For instance, Figure 2.5 provides the plot of the mean order completion delay versus  $\omega$ . As expected, we observe that for lower values of  $\omega$ , the customer delay is shorter, since the recoverable products' inventory is sufficient and the remanufacturer can respond to customer faster. As threshold value of  $\omega$  increases, the remanufacturer cannot respond quickly to customers. However, for a constant value of  $\omega$ , an increase in  $S$  from 4 to 8 dramatically decreases the expected customer completion delay. Two interacting factors contribute to this decrease in  $E(D)$ . First, the accepted number of returned products for remanufacture increases, and second, the remanufacturer has sufficient inventory to cushion against the supply and demand variations, and thus able to respond faster to orders. On the other hand, high values of  $\omega$  imply shortage of recoverable products in the inventory, resulting in increases in delay

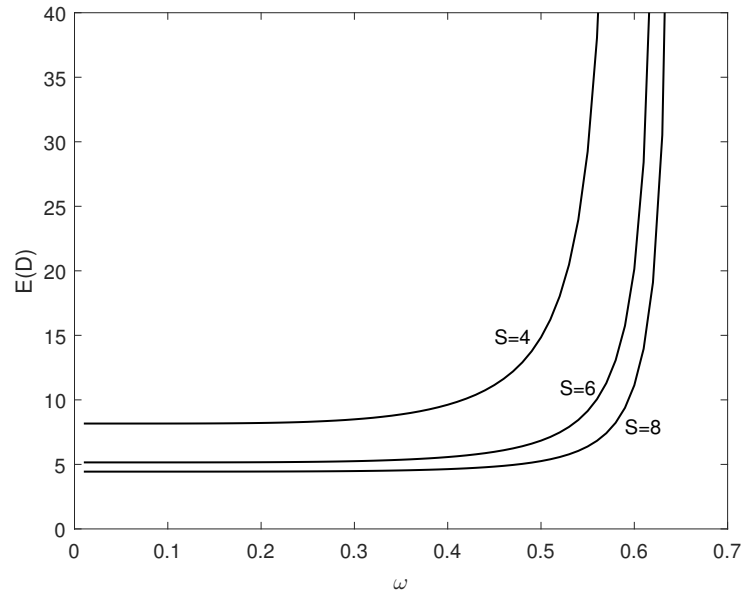

Figure 2.5: Expected customer order completion delay,  $E(D)$

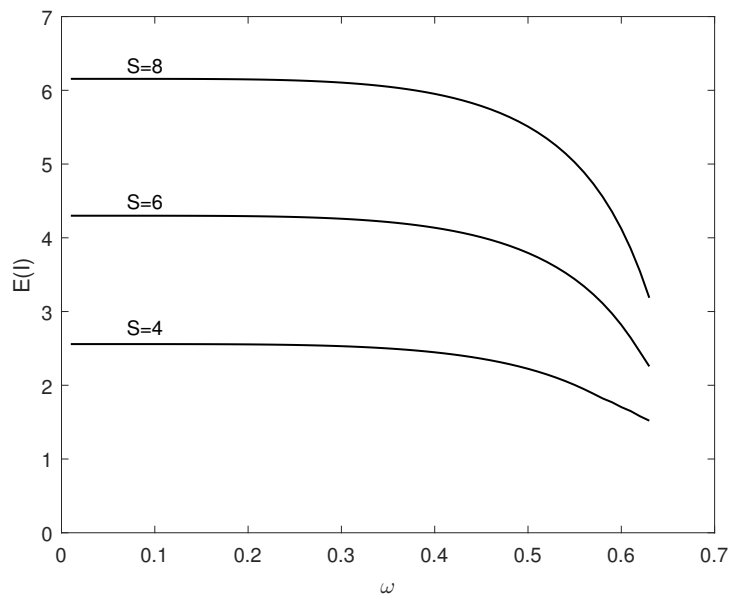

Figure 2.6: Expected number of recoverable product in storage,  $E(I)$

of order completion. These process nuances are depicted in Figure 2.6

Also shown in Figure 2.7, is that as  $\omega$  increases, the mean number of rejected products with lower quality grade than threshold value ( $E(P_1)$ ) increases to the point where accepted products to remanufacture is insufficient to meet customer orders. The graphs for  $S = 4, 6$  and  $8$  are overlaid, indicating that the inventory level does not quite influence the expected rejection rate for a given  $\omega$ . Figure 2.8 on the other hand, shows the impact

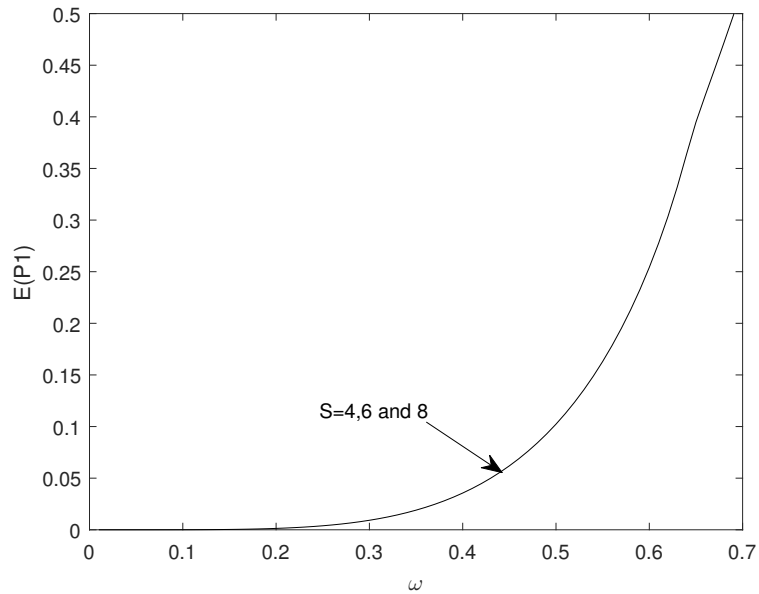

Figure 2.7: The expected number of rejected returned products following inspection,  $E(P1)$

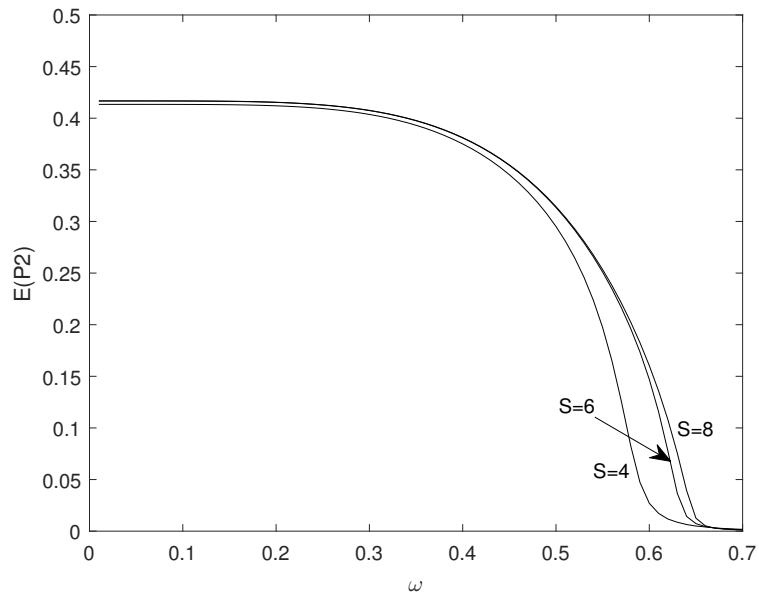

Figure 2.8: The expected number of returned product disposed when the storage is full,  $E(P2)$

of  $\omega$  on the expected number of returned products that have to be disposed off because the recoverable products inventory has reached its capacity. For small threshold values ( $\omega < 0.4$ ), the expected number of products disposed is more as it is a function of the acceptance rate. Once again there is quite an overlay of  $S = 4, 6, 8$  for lower values of  $\omega$ , then a sudden decrease in  $E(P_2)$  for all values of  $S$ , with  $S = 4$  decreasing the fastest as expected. Figure 2.8 illustrates the underlying interdependence between  $\omega$ , which determines the percentage of the incoming returns to accept and the recoverable product inventory capacity value  $S$ , which determines the speed with which customer orders would be completed. The next section will outline an economic framework of analysis wherewith the optimal values of  $S^*$  and  $\omega^*$  can be determined.

## 2.5 Optimization Problem

As discussed earlier, there are two paths when a returned product arrives: to accept it into the queue and gain revenue when it is remanufactured and sold, or to sell it as-is for a given salvage value. The assumption is made that a returned product may be disposed when the storage has reached its capacity or discarded during remanufacturing process. Therefore, this section presents a framework which utilizes a profit function that includes revenue from remanufactured products' sales, profits recovered from disposed products, and a cost function that encompasses a penalty for customer order completion delay, inventory holding costs and the associated costs with the expected number of discarded recoverable products. In order to maximize the profit, the remanufacturer seeks the optimal quality threshold value  $\omega^*$ , and the optimal inventory size  $S^*$ . Given that the system is assumed to be in a steady state, the profit is calculated as follows:

Total expected profit = (revenue from selling remanufactured products + revenue from selling disposed products as-is) - (cost of order delay + inventory holding cost for returned products + cost of discarding products that are not restored to predefined quality grade + cost of establishing recoverable storage)

The expected cost, revenue and profit factors of the remanufacturing system are mod-



eled as follows:

1. Revenue from the sale of the remanufactured products is  $RSM = E[M] \int_{\omega}^1 r(\omega) f_1(u) du$ .  
It is assumed that the unit prices of remanufactured products are not dependent on the the initial quality grade ( $\omega$ ), but the net revenue per unit time depends upon the initial quality.
2. Revenue from selling disposed product as-is is  $RSP = (E[P_1] + E[P_2])P(\omega)$
3. Cost of establishing recoverable storage with capacity  $S$  is  $CS = C_S S$
4. Cost of customer order completion delay is  $CD = C_d E[D]$
5. Inventory holding cost for recoverable products  $CI = C_h E[I]$
6. Cost of discarding recoverable products that are not restored to predefined quality grade is  $CW = C_w E[W]$

Therefore, the total expected profit ( $\Pi$ ), revenue ( $TR$ ) and cost ( $TC$ ) are:

$$\Pi(S, \omega) = TR - TC$$

$$TR = RSM + RSP$$

$$TC = C_S + CD + CI + CW$$

Thus, the remanufacturer problem that maximizes the expected profit can be stated mathematically as:

$$\max_{S, \omega} \{ \Pi(S, \omega) = E[M] \int_{\omega}^1 r(\omega) f_1(u) du + (E[P_1] + E[P_2])P(\omega) - C_S S - C_d E[D] - C_h E[I] - C_w E[W] \}$$

We can find numerically the optimal value of  $\omega^*$  and  $S^*$  that maximizes the profit; however, not much can be said about optimal values without further assumptions about  $r(\omega)$ . In the following section, fair assumptions for the remanufacturing costquality curve are made. In Section 2.6, we assess the value of admission control policy that classify returns into two different classes via a large-scale numerical study,

## 2.5.1 Remanufacturing net revenue and salvage value

Anecdotal information from the partner plant indicated that the remanufacturing cost increases as the quality grades decreases but selling price of remanufactured product is constant, any return not used may be salvaged, with the price varying based on the quality. A real number  $\omega \in [0, 1]$  is used to represent the return quality where  $\omega = 0$  is lowest quality and thus scrap and  $\omega = 1$  is the highest possible quality of returns. We assume that the firm does not have prior knowledge of the returns' quality status. However, the probability distribution of returns quality over  $[0, 1]$  is known a priori. According to the real case of PitneyBowes (studied by Ferguson et al. (2009)), the net revenue curve:  $SP - [a_0 + (a_1 - a_0)\omega^\beta]$  can be obtained. In this chapter, we assume that  $SP$ , the selling price of a remanufactured product is constant. The model parameter  $a_0$  represents the cost of remanufacture products with the lowest possible quality grade, which is assumed to be  $a_0 \in \{\$50, \$60\}$ . Correspondingly,  $a_1$  is the cost to remanufacture for products with the highest possible quality grade where  $a_1 \in \{\$5, \$15, \$25, \$35\}$  is used in this chapter. The preceding cost values match the observed industrial values of the products in the case study as and includes values there were used in Ferguson et al. (2009). We consider the value of  $\beta \in \{0.5, 1, 1.5, 2\}$  to be the shape factor of the remanufacturing revenue curve as represented in Figure 2.9. The four curves represent four distinct trends of increase in remanufacturing revenue with increasing quality levels. The remanufactured product's selling price  $SP$  is constant at 80 in all curves. As we discussed before, returns with lower quality necessitate more components to be upgraded, repaired or replaced and this indicates a higher cost to remanufacture or otherwise a lower salvage value. Therefore, the salvage revenue is calculated as  $P(\omega) = p * \omega$ , a function of the initial quality, where the constant value  $p$  is the maximum possible salvage when  $\omega = 1$ . We assume  $p = 5$ , which means that the salvage values range between (0, 5).

*Example:* Consider  $SP = 80$ ,  $a_0 = 80$ ,  $a_1 = 5$ ,  $\beta = 2$ ,  $\lambda = 1.35$ ,  $\mu = 1$ ,  $\gamma = 0.75$ ,  $P(\omega) = 5\omega$ ,  $\theta = 0.1$  and  $S = 7$ . Also, we assume that quality distribution of returns is Beta (5, 2). Figure 2.10 provides the plots of profit, revenue and cost functions versus  $\omega$ .

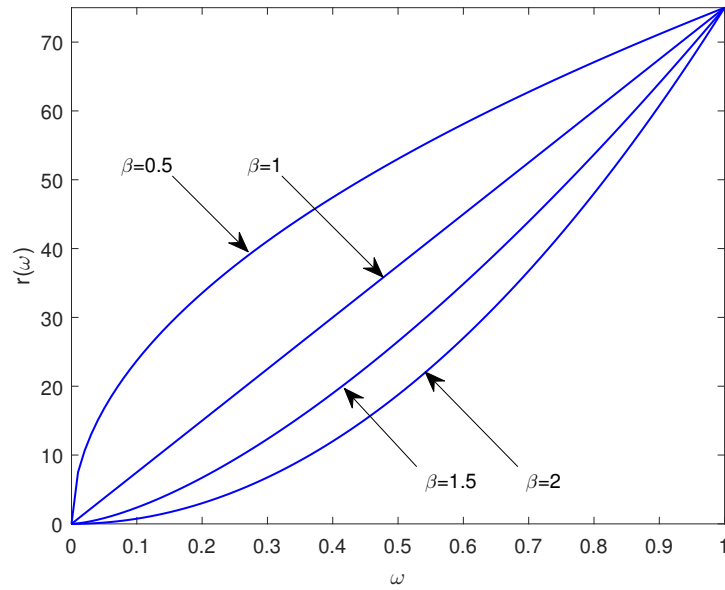

Figure 2.9: Remanufacturing net revenue curves  $r(\omega)$  in \$, with respect to  $SP = \$80$ ,  $a_0 = \$80$ ,  $a_1 = \$5$ .

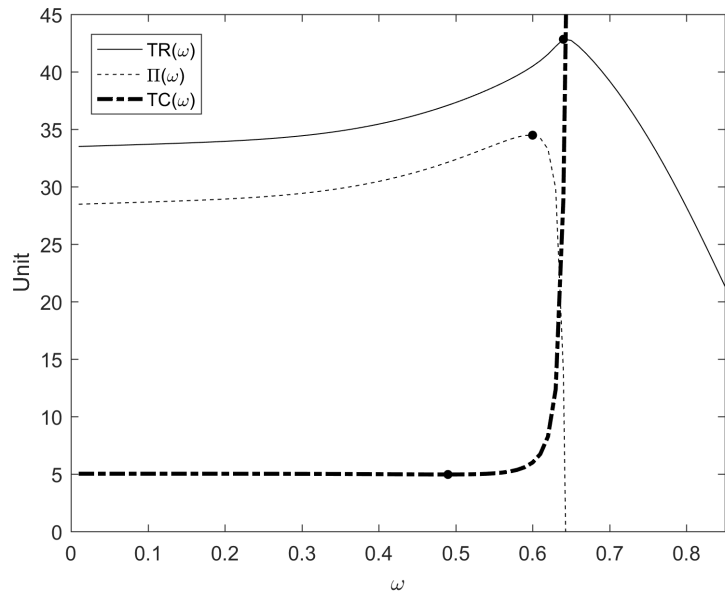

Figure 2.10: The expected profit, revenue and cost versus different minimum required quality grade.

Table 2.2 shows the values of  $\omega^*$ ,  $\Pi^*$ ,  $TR^*$ ,  $TC^*$  and  $F(\omega^*)$ . It can be noted that the optimal  $\omega^*$  values differ across the optimum values of  $\Pi^*$ ,  $TR^*$  and  $TC^*$ . The revenue is maximized when the minimum required quality grade is 0.64, in which case the percentage of rejected products is 30%. On the other hand, in order to minimize the total cost, returns with quality grade lower than 0.49 should be rejected. Finally, profit will be maximized if the threshold value is 0.6 and to obtain optimum profit, 23% of returned products needs to be rejected and sold as-is.

Table 2.2: Impact of minimum required quality grade on profit, revenue, cost and rejected returns

	Optimum value	Optimum threshold value $\omega^*$	Percentage of rejected returns $100\%F(\omega^*)$
Profit $\Pi^*$	34.48	0.6	23%
Revenue $TR^*$	42.83	0.64	30%
Cost $TC^*$	4.96	0.49	10%

## 2.6 Numerical Study

This section entails a detailed numerical analysis to assess the performance of the prior discussed admission policy to product disposition. The objectives of the study is to understand the impact of the characteristics of the proposed profit maximization approach and the factors involved; and to determine the conditions under which the proposed approach significantly outperforms the other admission policies.

A dataset is simulated to reflect the real business situation. Returns arrive randomly according to a Poisson process with the mean scaled to  $\lambda = 1.35$  (it may be helpful to think one unit in this simulation may represent as many as 1000 units in real life). A single exponential remanufacturing service rate is assumed to be  $\mu = 1$  and rate of orders to the facility is also Poisson with  $\gamma = 0.75$ . In this numerical study, the following parameter values are assumed unless stated otherwise:  $SP = \$80$ ,  $a_0 = \$80$ ,  $a_1 = \$5$ ,  $\beta = 2$ ,  $\lambda = 1.35$ ,  $\theta = 0.1$ ,  $c_d = 0.2$ ,  $c_h = 0.5$ ,  $c_w = 1$ , and  $P(\omega) = 5\omega$ .

### 2.6.1 Effect of recoverable product inventory Capacity

Table 2.3 provides an illustration of the optimal quality requirement ( $\omega^*$ ), for a variety of recoverable inventory capacity  $S$  that would optimize the profit, revenue and cost.

As we can see, the system is not stable when the inventory size  $S = 1$  for any  $\omega^*$ , meaning that at this inventory size the remanufacturer is not able to meet customer demand. As the remanufacturer increases the recoverable inventory capacity  $S$ , the system stabilizes and provides the optimal quality levels  $\omega^*$  for each value of  $S$ . When  $S = 2$ , to minimize the loss, almost all returned products need to be accepted for remanufacture.

As  $S$  increases further so does  $\omega^*$  which means it is advantageous for the remanufacturer to decreasingly accept products with lower quality grade to remanufacture, in which case, reducing inventory and remanufacturing costs are the primary drivers of the optimization model. For instance, when  $S = 5$ , the profit is optimized by accepting returned product with quality grade 0.56 and higher. Once  $S = 8$ ,  $\Pi^*$  begins to decline as a result of increasing cost of establishing recoverable product storage.

The recoverable products inventory protects the remanufacturer from fluctuations in the demand and supply of products. From Table 2.3, when  $S$  is low, variation in the return arrivals or quality of recoverable products may have a lot more negative effects on customer order completion caused by periodic process starvation. Therefore the remanufacturer has incentive to remanufacture lower quality products, choosing to incur higher remanufacturing costs due to lower quality grade products, for the sake of reducing the customer completion delay costs. On the other hand, larger  $S$  imply that the remanufacturer is able to absorb the process dynamics. As  $S$  gets much larger, the remanufacturer will choose to increase the minimum required quality grade in order to ensure adequate recoverable products in inventory with lower cost of remanufacture. Figure 2.11 also provides detailed indication of this behavior for total profit, revenue and cost functions for various recoverable inventory capacity. The fundamental observation made from the results so far is that while having a quality threshold is necessary, the consequence is its complex nexus with the size of recoverable products inventory. In the next few subsections, we present the sensitivity analysis results which shows how other aspects of the

Table 2.3: Impact of recoverable inventory capacity

S	$\omega^*$	$\Pi^*$	$\omega^*$	$RE^*$	$\omega^*$	$TC^*$
1	-	-	-	-	-	-
2	0.03	-101.76	0.31	49.29	0.01	150.95
3	0.42	31.66	0.54	46.67	0.01	5.14
4	0.53	33.31	0.6	44.85	0.01	3.79
5	0.56	34.06	0.62	43.77	0.01	3.99
6	0.58	34.40	0.64	43.20	0.32	4.45
7	0.6	34.48	0.64	42.83	0.49	4.96
8	0.6	34.41	0.65	42.63	0.54	5.46
9	0.61	34.26	0.65	42.51	0.56	5.95
10	0.62	33.99	0.65	42.40	0.58	6.44
15	0.63	32.34	0.65	42.15	0.62	8.84
20	0.64	30.17	0.66	42.13	0.63	11.22
25	0.64	28.14	0.66	42.12	0.64	13.62
30	0.64	25.78	0.66	42.13	0.64	15.99
35	0.64	23.17	0.66	42.13	0.64	18.59

problem setting may alter the optimal decision.

### 2.6.2 Effect of revenue-quality curve

The variability in the revenue-quality curves are modeled by three parameters  $(a_0, a_1, \beta)$  as explained in Section 2.5. The result of sensitivity analysis of these parameters are shown in Table 2.4. Overall, it is observed that for a constant shape factor  $(\beta)$ , for instance  $\beta = 2$ , and a constant cost of remanufacture for the highest possible quality return  $(a_1)$ , for instance  $a_1 = 5$ , the profit  $\pi^*$  increases with decreasing values of the values of  $a_0$ , the cost to remanufacture the worst quality return. To the contrary, the optimal quality threshold  $\omega^*$  and the optimal inventory capacity  $S^*$  decrease with decreasing values of  $a_0$ . The results illustrate that lowering remanufacturing cost, results in higher profits, which occurs when the minimum required quality is decreased which in turn enable the process to tolerate a reduced inventory capacity.

### 2.6.3 Effect of remanufacturing facility efficiency

In our model,  $\theta$  is the probability that an accepted returned product will not be processed properly and therefore wont be suitable for resale. We assumed a constant value for  $\theta$

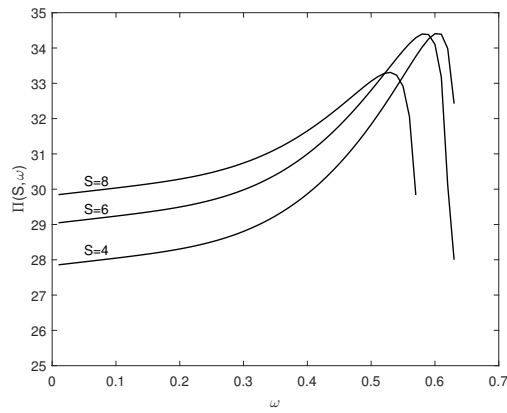

(a)

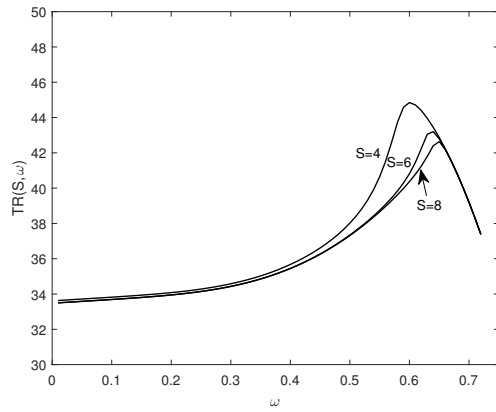

(b)

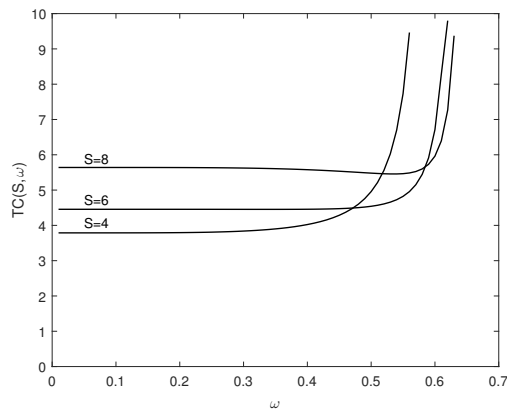

(c)

Figure 2.11: Impact of recoverable product inventory capacity on profit, revenue and cost. (a) profit functions, (b) revenue functions and (c) cost functions versus different minimum required quality grades for various  $S$ .

Table 2.4: Impact of net revenue-quality curve

$\beta$	$a_0$	$a_1 = 5$			$a_1 = 15$			$a_1 = 25$			$a_1 = 35$		
		$\Pi^*$	$\omega^*$	$S^*$	$\Pi^*$	$\omega^*$	$S^*$	$\Pi^*$	$\omega^*$	$S^*$	$\Pi^*$	$\omega^*$	$S^*$
2	80	34.48	0.6	7	29.28	0.59	7	24.1	0.59	7	18.98	0.57	6
	70	37.64	0.59	7	32.48	0.58	6	27.36	0.57	6	22.26	0.56	6
	60	40.87	0.58	6	35.73	0.57	6	30.63	0.57	6	25.62	0.53	5
	50	44.11	0.58	6	39.02	0.55	5	34.01	0.53	5	29.07	0.51	5
1.5	80	39.13	0.59	7	33.33	0.58	6	27.56	0.57	6	21.83	0.57	6
	70	41.72	0.58	6	35.94	0.58	6	30.2	0.57	6	24.48	0.56	6
	60	44.33	0.58	6	38.58	0.57	6	32.87	0.54	5	27.24	0.53	5
	50	47.18	0.43	3	41.28	0.42	3	35.63	0.53	5	30.04	0.51	5
1	80	44.62	0.58	6	38.11	0.57	6	31.63	0.57	6	25.17	0.56	6
	70	46.5	0.58	6	40.01	0.57	6	33.55	0.54	5	27.15	0.53	5
	60	48.76	0.43	3	41.96	0.55	5	35.54	0.54	5	29.17	0.52	5
	50	51.21	0.43	3	44.4	0.42	3	37.7	0.4	3	31.24	0.46	4
0.5	80	52.09	0.44	3	44.16	0.42	3	36.54	0.53	5	29.25	0.52	5
	70	53.44	0.44	3	45.51	0.43	3	37.71	0.4	3	30.36	0.52	5
	60	54.8	0.44	3	46.87	0.42	3	39.07	0.4	3	31.51	0.46	4
	50	56.15	0.44	3	48.22	0.42	3	40.42	0.4	3	32.77	0.36	3



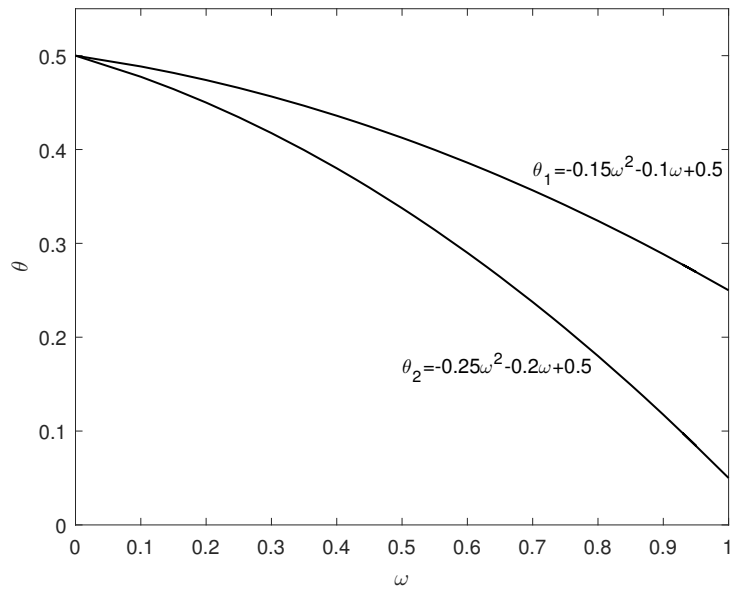

Figure 2.12: Remanufacturing facility efficiency - quality curve.

in previous numerical examples, but in real cases, the remanufacturing facility efficiency depends on the initial quality of returned products. In this section, a quadratic function is used for the efficiency curve as follows:  $\theta(\omega) = c_2\omega^2 + c_1\omega + c_0$ .

Figure 2.12 shows two shapes for the remanufacturing facility efficiency rate curve. They represent distinct trends of increasing efficiency as a function of the quality of recoverable products. In all curves  $c_0$  is constant at 0.5 defined as lowest efficiency rate for products with lowest possible quality grade. Figure 2.12 also shows that  $\theta$  increases when  $\omega$  decreases to reflect the risk that a remanufacturer is not able to recover a low-quality return to the required market quality. For example, for both product types, represented by the two curves, 50% of recoverable product with lowest possible quality grade will not be suitable for resale after remanufacturing. This figure shows that efficiency rate for remanufacturing product type 2 is highly dependent on quality of returns than product type 1. This low recovery rate occurs when, for instance, it is necessary to include additional process components, require highly skilled technicians and even add more components to remanufacture a product with lower quality grade. In doing so, it increases the probability that remanufacturer is not able to do or provide all needs to recover this product. This interplay has been presented in details in a previous study

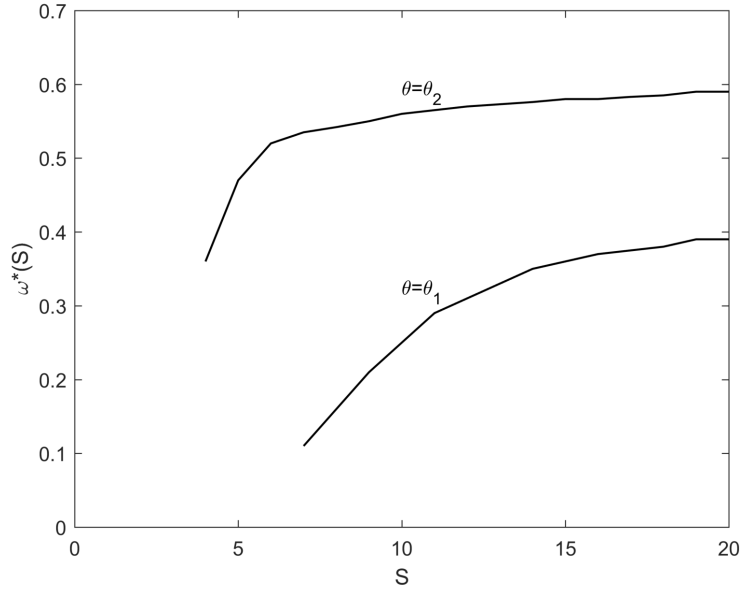

Figure 2.13:  $\omega^*(S)$  for various  $S$ .

done by Omwando et al. (2018). We have performed a series of numerical experiments to investigate the influence of value of  $\theta$  on the remanufacturers selection of  $\omega^*$  over a range of  $S$  as shown in Figure 2.13. For both  $\theta_1$  and  $\theta_2$ ,  $\omega^*$  consistently increases as  $S$  is increasing, results that are consistent with the discussion in Section 6.1. This also shows that the trade-off between quality and inventory capacity is not sensitive to the product type. Also, for any recoverable inventory capacity  $S$ , the  $\omega^*$  of returns with the lower efficiently rate  $\theta_1$  is lower than that of the higher efficiency, as the remanufacturer wishes to take in more returns to cushion against process starvation.

#### 2.6.4 Effect of demand rate (system load)

When the remanufacturer decides on the recoverable product inventory size and the threshold quality grade, the existing system configuration may need to be changed if the demand rate is changes. Table 2.5 depicts such a scenario. As the system load( $\gamma$ ) increases,  $S^*$  increases to protect the remanufacturer from a shortage. Also the results shows that the optimal minimum required quality  $\omega^*$ , is decreasing as  $\gamma$  increases. It would be expected that to lower the cost of remanufacture, the organization would always seek to increase  $\omega^*$ . The results in this sensitivity analysis show the trade-off which leads

to a decrease in  $\omega^*$  due to additional pressure to avoid process starvation, and thus prioritizes a decrease in the cost of delay than the cost of remanufacture. Considering

Table 2.5: Optimal solution for various  $\gamma$  and  $\theta$

$\gamma$	$\theta = 0.1$			$\theta_1$			$\theta_2$		
	$\Pi^*$	$\omega^*$	$S^*$	$\Pi^*$	$\omega^*$	$S^*$	$\Pi^*$	$\omega^*$	$S^*$
0.1	10.07	0.85	2	11.48	0.85	2	10.2	0.86	2
0.2	15.45	0.82	2	18.03	0.79	2	15.72	0.81	2
0.3	20.15	0.79	3	23.89	0.75	3	20.73	0.78	3
0.4	24.41	0.75	3	29.05	0.7	4	25.37	0.73	3
0.5	28.13	0.71	4	33.41	0.64	5	29.48	0.69	4
0.6	31.26	0.67	5	36.79	0.56	6	32.96	0.64	5
0.7	33.64	0.62	6	38.7	0.43	8	35.6	0.57	6
0.8	34.99	0.56	8	31.41	0.06	21	36.92	0.46	8
0.9	34.26	0.43	10	-261.31	0.01	30	34.09	0.16	16
1	-1.7	0.08	31	-417.67	0.01	32	-163.84	0.14	35

how  $\theta$  affects the optimal choice of  $\omega$  and  $S$ , we observe in Table 2.5 that higher  $\theta$  values result in larger values of  $S$  and smaller values of  $\omega^*$ . This is intuitive because a larger recoverable product inventory is required to protect the remanufacturer from possible variations or shortages in the supply of recoverable products in the face of an imperfect remanufacturing system.

### 2.6.5 Effect of remanufacturing facility capacity

So far, the model has assumed that the service rate  $\mu = 1$ . Table 2.6 demonstrates the impact of the remanufacturing rate on the process decisions, where for a given value of  $\theta$ , as  $\mu$  increases from 0.5 to 1.5, the system responds by reducing  $S^*$  while increasing  $\omega^*$ .

## 2.7 Conclusions

Throughout this chapter, we have addressed the disposition decision that a remanufacturer has to make regarding the returns which have diverse quality levels. We first developed a model for optimal decision making that considers the quality of returns and recoverable product capacity. Secondly, we developed an optimization model to derive dynamic optimal quality levels of product returns and the optimal recoverable products

Table 2.6: Optimal solution for various  $\gamma$ ,  $\mu$  and  $\theta$ 

$\theta$	$\mu$	$\gamma = 0.5$			$\gamma = 0.75$			$\gamma = 1$		
		$S^*$	$\omega^*$	$\Pi^*$	$S^*$	$\omega^*$	$\Pi^*$	$S^*$	$\omega^*$	$\Pi^*$
0.1	0.5	8	0.29	0.64	35	0.71	-706.02	11	0.63	-1025.42
	0.6	6	0.69	24.16	35	0.7	-380.61	26	0.6	-696.93
	0.7	6	0.71	26.32	13	0.08	-148.58	35	0.6	-430.78
	0.8	5	0.71	27.27	8	0.47	28.95	35	0.61	-273.94
	0.9	4	0.71	27.77	8	0.58	32.92	35	0.59	-245.44
	1	4	0.71	28.13	7	0.6	34.48	31	0.08	-1.7
	1.1	4	0.72	28.36	6	0.6	35.33	13	0.24	34.82
	1.2	4	0.72	28.54	6	0.61	35.85	10	0.33	37.94
	1.3	4	0.72	28.66	5	0.6	36.22	9	0.37	39.35
	1.4	3	0.71	28.77	5	0.61	36.48	8	0.38	40.18
$\theta_1$	1.5	3	0.71	28.86	5	0.61	36.71	7	0.38	40.71
	0.5	13	0.22	-3.95	33	0.6	-697.55	11	0.03	-1010.2
	0.6	7	0.61	29.18	33	0.6	-357.84	13	0.34	-688.84
	0.7	6	0.63	31.52	27	0.16	-265.55	35	0.04	-435.42
	0.8	6	0.64	32.5	20	0.14	28.96	25	0.18	-338.57
	0.9	5	0.64	33.07	12	0.2	36.53	26	0.17	-346.36
	1	5	0.64	33.41	10	0.25	38.62	31	0.25	-417.67
	1.1	4	0.64	33.65	9	0.28	39.64	35	0.2	-422.78
	1.2	4	0.64	33.86	8	0.28	40.27	15	0.15	-400.12
	1.3	4	0.64	34	7	0.28	40.69	16	0.13	-370.39
$\theta_2$	1.4	4	0.64	34.1	7	0.29	40.98	11	0.18	-353.32
	1.5	4	0.64	34.17	6	0.28	41.21	11	0.15	-334.86
	0.5	10	0.29	-0.93	33	0.68	-702.05	11	0.57	-1010.08
	0.6	6	0.66	25.56	35	0.68	-392.47	26	0.52	-694.24
	0.7	5	0.68	27.67	18	0.06	-182.74	35	0.53	-428.72
	0.8	5	0.69	28.62	10	0.37	30.33	33	0.53	-256.83
	0.9	4	0.69	29.12	8	0.5	34.87	35	0.51	-256.47
	1	4	0.69	29.48	7	0.53	36.49	35	0.14	-163.84
	1.1	4	0.7	29.69	7	0.54	37.34	35	0.14	-72.91
	1.2	4	0.7	29.86	6	0.54	37.9	32	0.11	-44.91
1.3	3	0.69	29.99	6	0.55	38.26	24	0.02	-32.22	
1.4	3	0.69	30.11	5	0.54	38.54	26	0.02	-24.4	
1.5	3	0.69	30.21	5	0.55	38.75	17	0.12	-19.28	

inventory capacity for a general remanufacturing facility with diverse return quality levels, to get an understanding of how the quality of returns affects the trade-off between the minimum required quality grades and recoverable product inventory capacity. Our model was motivated by the quest of the operation managers at a partner remanufacturing facility to improve managerial operational and tactical decisions. Though the model is informed by the case facility, it is general enough that it can be applied to other firms that deal with quality and inventory driven remanufacturing processes.

Based on extensive numerical studies, we found that for smaller recoverable product inventories, variations in the return arrivals and quality of recoverable products have an impact of the customer order completion delay due to periodic process starvation. When these variabilities are incorporated into the decision process, the remanufacturer is able to absorb the process dynamics for larger recoverable inventories. As the inventory increases, the remanufacturer will choose to increase the minimum required quality grade in order to ensure adequate recoverable products in inventory with lower cost to remanufacture. In addition, effects of quality dependent revenue and facility efficiency were investigated. The results also show that if a remanufacturer has made decisions on its recoverable product inventory size and the minimum required quality grade, the existing system configuration may need to be changed if the demand rate is changed. For example, when the system becomes more loaded, there is a need of larger inventory to shield the remanufacturer from shortages. Also the results show that the optimal minimum required quality  $\omega^*$ , decreases with increasing  $\gamma$  values. Finally, we conclude that it is vital for the remanufacturer to understand the expected demand level, the supplier's ability to provide recoverable products to remanufacture and the optimum (i.e. minimum) returns quality grades to accept so as to maximize the profit.

---

## Chapter 3

# Environmentally Friendly Disposition Decisions for End-Of-Life Electrical and Electronic Products: The Case of Computer Remanufacture

### 3.1 Introduction

In last few years, with increasing concerns regarding the constrained usage of natural resources, environmental sustainability challenge and enforced take-back laws, the impact of disposing end-of-life (EOL) products has received considerable attention. OEM's are therefore obligated to consider cradle-to-grave strategies in their manufacturing businesses. Remanufacturing is one of the feasible forms of EOL strategies in which the used products are restored to 'like-new' condition (Du et al., 2012). Remanufacturing, if well organized and planned, can improve business outcomes such as increased productivity, gains in government-driven environmental sustainability incentives and improved customer relations. Remanufacturing further increases profits and the market share of manufacturing companies through cost saving from reducing landfills, expanding product life cycle, recapturing value and recovering assets, which is often the case with high tech products that have shorter life cycles (e.g. computers and printers) (Abdulrahman et al., 2015; Giannetti et al., 2013).

Over the last two decades personal computers (PC) have become ubiquitous and indispensable in our daily lives. The average useful life of a computer is progressively decreasing because of the expeditious growth in product versatility, and changes in features and functions. This causes a growing volume of obsolete PCs headed to the waste-streams. The presence of poisonous rare earth metals and the non-biodegradable nature of PCs have also led to increasing concerns regarding their environmental impact. Reuse,

recycle, incineration and landfilling are the available options at the end of life of personal computers (Ahluwalia and Nema, 2007). Specifically, it is reported that in the U.S.A. alone, more than 142,000 computers are discarded by recycling, disposal into landfills or through incineration on a daily basis (EPA, 2008). To the contrary, most computers are still good enough for continued use or refurbishment (Sahni et al., 2010). This requires finding a cost-effective method of making decisions on EOL product recovery options to facilitate computer remanufacturing (Cho et al., 2017; Sahni et al., 2010).

This study focuses on the increasing EOL product returns, that is, products in their last stages of their service life but still have the potential for value addition such as through the acquisition of reusable materials and parts. This is of most importance when dealing with products whose parts and material are expensive to dispose off. This study focuses on the economics of remanufacturing, which is the processes of recapturing value from collected end-of-life products through reusing the components for (re)manufacturing, or re-marketing after restoring the products to their original condition. According to (Geyer et al., 2007), remanufactured products may not be perfect substitutes for newly manufactured products; however, the case of perfect substitution dominated much of close-loop supply chain and remanufacturing research, although the case with no perfect substitution is more applicable in today's practice (Akçalı and Cetinkaya, 2011).

Our research was motivated by a PC remanufacturer, whose firm receives obsolete computers from the primary market. The obsolete computers could be remanufactured or dismantled for parts for the purpose of recovering value. In order to maximize the expected profit, firms should find the optimal allocation of returns to one of these options. Therefore, we provide a decision model for finding the optimal disposition decision for this case study which is general enough to be applied to other remanufacturing applications for example, photocopiers, cellular telephones and automotive industries. In all of these cases, the returned products can be resold after remanufacturing, dismantled for materials recovery without necessarily requiring any significant process.

There are however business and logistical challenges to the remanufacturing process, including, return quality variation, uncertainty in the supply of returns and demand for

remanufactured products and processing or yield uncertainty. Thus, product acquisition management could help firms to access reliable volume of returns that can satisfy the demand cost-effectively by controlling the uncertainty in the quality, quantity and arrival time of returns.

Due to the usage conditions, the quality of returns varies significantly amongst the returned products. Since the remanufacturing cost is significantly higher for low quality returns, dismantling or disposing them may be the most appropriate decision for such products. The remanufacturer is therefore in need of a decision support system that can incorporate quality variations into the deliberations. The existing literature on remanufacturing systems has not adequately addressed the quality uncertainty in returns (Akçali and Cetinkaya, 2011). We have modeled the acquisition price and remanufacturing cost as function of the quality in this study. The returns are thoroughly inspected and remanufacturer assigns a grade to the returned products where the acquisition price and remanufacturing cost depend on the quality grade.

This study contributes to the literature by first proposing the quality grading method and disposition decision for the returned products. The second contribution is a proposed general framework for the considered third party remanufacture with return quality decision. Third, a mixed integer non-linear programming model is developed for the integrated production planning to determine the minimum required quality grade to accept into the remanufacturing facility and quantity of parts purchased from external suppliers in order to maximize the profit. Finally, the operational consequences (e.g. capacity of the facility) in such a remanufacturing setting are evaluated.

As a natural starting point, we position our research in Section 3.2 in the context of the relevant studies to this problem. Section 3.3 explains the background of computer remanufacturing process. Then a brief description of the problem, basic assumptions, notation and corresponding mathematical model presented in Section 3.4. A case study of PC remanufacture is presented in Section 3.5.1 and later we apply the model for assessing the impact of quality, non-uniform volume of returns, cost of remanufacturing process and capacity of each site and quality grading method of returned products in a



multi-period production planning context. Finally, the results and concluding remarks are presented in Section 3.6.

## **3.2 Literature review**

Our study stems from three remanufacturing-related streams of the literature, namely, production planning in remanufacturing systems, implications of quality uncertainty in returns and EOL option decision modeling. The following three sections review the literature related to each stream.

### **3.2.1 Inventory control and Production Planning in Remanufacturing Systems**

A production planning system for remanufacturing firms supports managers to plan how much and when to remanufacture, how much and when to disassemble, reassemble, dispose off for salvaging and how much of virgin material should be acquired to replace work-out parts (Guide, 1999; Matsumoto et al., 2016). There exist vast literature that addresses the inventory control and production planning with product returns (see e.g. Fleischmann et al. (1997); Ilgin and Gupta (2010); Junior and Filho (2012)). Fleischmann et al. (1997) gave a general overview of quantitative models used in production planning and inventory control of reverse logistics. Specifically, they observed that as quality of returns is uncertain, production planning can be significantly impacted than in traditional forward-only networks.

In one of the earliest study in remanufacturing systems related to production and inventory control, Heyman (1977) investigates a continuous-review inventory control system where returns are disposed when the inventory level reaches a specified level under the assumption of zero lead times and zero repair times. Muckstadt and Isaac (1981) developed an approximate control strategy under continuous review procurement policy for a hybrid system. They considered the setup costs for remanufacturing, inventory cost of recoverable products and backorder costs, but there is no option to dispose unusable

returned products. Their work was later extended by Van der Laan et al. (1996) to include product disposal options for returned items. Van Der Laan et al. (1999) studied the production planning and inventory control problem in another work that involves both manufacturing and remanufacturing processes. The authors finally compared PUSH and to PULL controlled systems with remanufacturing with the traditional systems without remanufacturing.

In view of the production planning models for remanufacturing systems that are most pertinent to our work, Clegg et al. (1995) developed a production system from the perspective of a remanufacturer to examine the impact of demand rates, production and disposal costs and role of government on the economic viability of remanufacturing scheme. Gupta and Veerakamolmal (2001) developed a mathematical-based model which seeks to determine the quantity of parts needed to remanufacture products and quantity of products needed to disassemble in each time-period. In another work, Jayaraman (2006) presented a linear programming model to optimize the production planning and control for a reverse logistics network with prespecified inventory levels and zero lead times. Kim et al. (2006) presented a mathematical model for a remanufacturing system, where in order to supply the components, the remanufacturer can order the required units from an external suppliers or dismantling the returned products and restore the disassembled components to as new conditions. The proposed model maximize the total cost saving by determining the optimum quantity of components that need to be purchased from external suppliers or restored in the facility.

To extend previous studies by Balakrishnan and Geunes (2000); Golany et al. (2001) and Richter and Sombrutzki (2000), Li et al. (2006) investigated a multi-product, multi-period production planning problem in a hybrid manufacturing-remanufacturing system, where backlog and disposal is not permitted. They also determined the time and amount of returns that needs to be remanufactured or new products that needs to be manufactured in order to minimize the total cost. Denizel et al. (2010) formulated a stochastic programming model considering variability in the product returns condition to find the number of units to remanufacture for each quality grade, held or disposed at each period

of time. Additionally, Das and Chowdhury (2012) formulated a mixed integer programming (MIP) model for overall planning process required to maximize profit with product design decisions and quality considerations.

The model given by Nikolaidis (2009) was extended later by Nenes and Nikolaidis (2012) to incorporate multiple planning periods. The authors developed a mixed integer linear programming model for the optimization of procurement, remanufacturing, salvaging and stocking decisions. In their study, the remanufacturing company might choose to acquire all, some, or none of the batches of returned products. In similar studies, Mahapatra et al. (2012) investigated an integrated production planning and inventory control problem for an office equipment manufacturing firm that utilizes both virgin and remanufactured printer cartridges to meet demand. They have also examined the impact of diverse quality of returns and determined the optimal production plan over planning horizon using a mixed integer linear programming (MILP) model. Recently, Han et al. (2016) developed a robust optimization approach to determine the optimum production plan for a hybrid manufacturing-remanufacturing system under the assumptions of uncertainty in market demand and quality variation of the returns. They have also analyzed these uncertain parameters and pricing strategies of the original equipment manufacturers (OEMs).

### **3.2.2 Implications of quality uncertainty in returns**

Although the growing body of literature has emphasized the importance of production planning and control for cost-effective remanufacturing systems (see, e.g., Golany et al. (2001); Jin et al. (2011); Teunter (2006)), we found that research on the effect of quality uncertainty on optimal manufacturing-remanufacturing is relatively new and there are few studies that consider quality uncertainty. The variable remanufacturing cost highly depends on the quality grade and salvage value for the returns.

The quality of returned product has often been modeled using a probabilistic yield rate to determine the probability that a product would be successfully restored. Here, a returned product is either remanufacturable or it is not and the costs associated with

remanufacturing are not quality dependent. Bakal and Akcali (2006) analyzed remanufacturing of end-of-life products in the automobile remanufacturing industry in the US, in which random yield depends on the acquisition price and customer demand depends on the selling price. In their work, they have assumed that amount of returns and demand are deterministic. Dobos and Richter (2006) considered the quality of returns in an integrated production recycling system with two alternatives: buyback all returns and use a proportion of returns that are serviceable or buyback only proportion of products that are serviceable.

To extend this work, El Saadany and Jaber (2010) assumed that the return rate depends on acquisition price and acceptance quality grade. Zikopoulos and Tagaras (2007) examined a reverse supply chains under yield uncertainty in which the sorting procedure classifies items as recoverable or non-recoverable before disassembly and remanufacturing of used products. Mukhopadhyay and Ma (2009) formulated a two-stage stochastic model to determine the optimal procurement and production decisions for a remanufacturing system under assumption of uncertainty in quality and demand.

In Ferguson et al. (2009), the cost to remanufacture is dependent of the quality of returns, and the quality of each return is the realization of a random variable between 0 and 1, where  $q = 0$  is non-remanufacturable and  $q = 1$  is the return with highest possible quality. The authors assigned beta distribution to quality uncertainty, which is the commonly used prior probability for the proportion parameter. Hein et al. (2012); Van Wassenhove and Zikopoulos (2010); Watanabe et al. (2013) have also assumed that the quality levels of returns lies between 0 and 1 and it also follows a beta distribution. In Galbreth and Blackburn (2010), the condition of acquired cores in a lot is uniformly distributed. The work provided closed form solution of the optimal acquisition quantity that minimizes the total costs. Van Wassenhove and Zikopoulos (2010) address the effect of quality over-estimation of returns in a reverse supply chain in which the returns are inspected by both suppliers and remanufacturers. Their study evaluated the effect of quality overestimation of returned products on the optimal procurement decisions and systems profitability. Robotis et al. (2012) considered random quality of returns as the

source of uncertainty in remanufacturing cost, and studied its impact on the investments in design for re-usability. Recently, Radhi and Zhang (2016) proposed a MINLP model for a supply network to maximize the profit by determining the minimum required quality grade. In their research, two cases of normal and exponential distribution for quality of returns were studied and their impact on the systems behavior analyzed.

In some other cases, condition variability is represented through the use of discrete random variables. Behret and Korugan (2009) examined a hybrid manufacturing/re-manufacturing system where returns are categorized into three different classes (good, average and bad) based on their quality. The authors concluded that cost saving for the quality based categorization compared to a system with no quality categorization is significant. Teunter and Flapper (2011) have considered pre-specified number of quality types (grades) for returns which follow a multinomial distribution with deterministic parameter values and they have determined optimal acquisition in addition to other re-manufacturing policies of the proposed model. Mahapatra et al. (2012) developed a mixed integer linear program (MILP) to determine the optimal production plan for a hybrid manufacturing system in which the returns have heterogeneous quality. In their work, returns are classified into limited number of classes that characterizes the amount of work needed to restore them to 'like new' condition. They later evaluate the effects of quality, quality based classification, cost of capacity readjustments, and trade-offs among different operational costs.

### **3.2.3 End-of-Life option decision modeling**

Given the potential EOL alternatives for a returned products such as disposal, recycling, re-use, repair, or remanufacturing, it is of great importance to the (re)manufacturers to decide which alternative (or combination of alternatives) achieves the highest recovery value for each product (Behdad et al., 2010).

Inderfurth et al. (2001) as the first work to investigate a stochastic remanufacturing problem with multiple remanufacturing alternatives (e.g. upgrade, downgrade, like-new) for returned products. Kaebernick et al. (2002) developed a decision-making model to

evaluate products, compare the values of new produced part with an used part and finally determine the best decision among the several alternatives (reuse, remanufacture or disposal). Inspired by the Bufardi et al. (2004), Chan (2008) proposed a method based on grey relational analysis (GRA) to select the appropriate EOL method of the parts of an electrical shaver while taking into consideration the social, ecological, environmental and economic factors. Hedayati and Subic (2011) developed a conceptual framework to identify the most sustainable alternative for recovery of end-of-life vehicles(ELVs) based on best current practice in industry. In Behdad et al. (2012), developed a stochastic model to identify the most suitable end-of-use option for returns under the assumption of uncertainty in quantity of returns. Their model determines the level of disassembly for products and also the best alternative end-of-life alternative for each sub-assembled product.

The necessity, importance and EOL operation issues of personal computers have been discussed in several studies. For example, in study of economics of PC remanufacturing, Ferrer (1997) discussed the challenges of personal computer (PC) remanufacturing and also complexity of developing an acceptable recovery process. Ahluwalia and Nema (2007) presented a life cycle based decision support model for a case study of computer waste scenario in Delhi, India. Their model evaluates the waste management cost and reuse time span of different routes of obsolete computers to determine the optimal configuration for facilities, transportation routes, waste allocation to the different facilities. Mashhadi et al. (2015) proposed a stochastic optimization model in order to help remanufacturers to identify the most profitable upgrade level for a used product. They evaluated their model by applying their approach for a case of PC remanufacturing where the PCs have different quality grades. In recent work, two different search algorithms developed by Cho et al. (2017) to determine the best EOL alternative for the computer components. The authors have also proposed the conditional repair option to maximize the profit.

Until now we have looked into the main three separate streams of the literature relevant to our research. Even though many researchers contributed to different aspect of product planning and inventory control in remanufacturing systems and/or EOL product

recovery selection problem, we identified a few limitations.

First, to the best of our knowledge, among previous studies, none examined the impact of quality uncertainty of a remanufacturing firm concerning procurement, remanufacturing, disassembling, salvaging and stocking used products, for multiple periods of time. Second, little research has been conducted with regard to determining an EOL option for a remanufacturing production planning and control. Third, most existing models considered production planning for EOL recovery with focus on two different EOL alternatives for a returned product, even though a combination of multiple alternatives for products and parts is more practical. Finally, there are only a few works related to EOL product remanufacturing issues that includes quality uncertainty in multi-product, production planning in capacitated remanufacturing with regards to long-term planning.

In this chapter, we account for several important aspects that prior works haven't addressed such as quality and how it relates to several remanufacturing attributes, (for instance the acquisition price of the return and the cost to remanufacture), inventory holding costs, non-uniform rate of returns, capacity constraints, and multi-product-multi-period production planning that reflect the concerns of current remanufacturing firms. Unlike most previous studies, we considered different routes for each returned product or disassembled parts. Also, this study assumes quality follows beta distribution. The numerical study helps to understand the impact of the proposed quality grading method and EOL decision under quality uncertainty and unsteady volume of returns. The formulation described in the following section.

## **3.3 Background**

### **3.3.1 The importance of computer remanufacturing**

Personal computers (PC) have quickly become indispensable products especially given current low costs. The amount of personal computers sold around the globe has increased from thousands in the early eighties, to over 260 million in 2016 (Matthews and Matthews, 2003; Vanian, 2017). In addition, the useful lifespan of computers is relatively

short, and has diminished drastically as result of expeditiously growing versatility and improving functionality during the last two decades, resulting in increasing volumes of obsolete computers and other electronic components around the globe. In 2008, the U.S Environmental Protection Agency (EPA) estimated that Americans discarded 142,000 computers either by recycling or disposing of them in landfills and incinerators on an average per day (EPA, 2008). Because of this, concerns have risen to combat the volume of PCs being disposed and the environmental impacts of their hazardous materials.

An analysis was conducted by the United States Environmental Protection Agency to promote environmentally friendly end-of-life computer options. They found that land-filling of personal computers was far more common than recycling or incineration (EPA, 2008). However, most computers that are disposed off are still in good working condition especially for functions that require less intensive computing capabilities (Sahni et al., 2010). Therefore, it is better for the society to consider PC remanufacture or reuse rather purchasing new PC which dictates the upstream management of computer wastes(Cho et al., 2017; Williams and Sasaki, 2003).

Upstream management of the computer waste stream is elimination or minimization of wastes by extending its usable lifespan (Williams and Sasaki, 2003). If consumers go longer between purchases of computers, the need for manufacturing new computers decreases, immediately saving energy and reducing environmental impacts caused by the manufacture and production of raw materials. In addition, the size of the waste stream is decreased moving forward (Sahni et al., 2010).

There are four options for the disposition and recovery of computers after they have been used by their first purchaser. One can reuse/resell, do a product upgrade, do a material recovery or waste management. There are recovery/disposal alternatives for each option as well. One aspect to note is that the incineration of e-waste is globally frowned upon because these type of devices are a source of carcinogens and toxins. Table 3.1 presents and explains the PC EOL options.



Table 3.1: The EOL options in PC recovery and the relevant alternatives

PC EOL options	Recovery/disposal alternatives
Reuse/resell	<b>Reuse/resell</b> It is reselling a computer into a secondary market after collecting from the first customers (Govindan and Popiuc, 2014).
Upgrade	<b>Repairing/Remanufacturing/Refurbishing</b> It is bringing back the returned computers in to a determined quality grade. This involves inspection, replacement of certain parts with newer versions, updating the softwares (Mashhadi et al., 2015).
Materials recovery	<b>Cannibalization/ Recycling</b> It is Disassembling and dismantling of a used computer in order to recover parts or materials. The parts could be reused in repairing, refurbishing or remanufacturing of other computers (Ahluwalia and Nema, 2007; Williams and Sasaki, 2003)
Waste Management	<b>Disposal.</b> If there is no value added in used computers or disassembled parts, they will be disposed of (Cho et al., 2017).

### 3.3.2 Computer remanufacturing process

Similar to Govindan and Popiuc (2014), we assumed that the process for recycling follows a closed loop supply chain in which the computers come back to the remanufacturer using the same distribution channel as the one used to sell new computers. This processes is visualized in Figure 3.1. The retailer collects obsolete computers (cores) by means of consumer drop-off and sends them down the supply chain (Atasu and Souza, 2013). The retailer sends the PCs to the distributors who receive them and send them to the authorized remanufacturer who, in turn, remanufactures/refurbishes and they are sold to the secondary market through different channels. Remanufacturers may source the cores from various channels:

- **Off leasing:** off lease computers are any computers that were purchased on lease and then returned to the leaser (producer or its channel partner).
- **Asset recovery:** it is one of the biggest sourcing channel for remanufacturers. The service providers collect the obsolete computers for remanufacturing, components reuse or recycling. Customers of producers such as Dell, HP can purchase services like this in order to liquidate idle assets, secure hard disk data destruction or just safe disposal (Hsieh, 2010).
- **Donation:** there are many foundations and organizations that accept or facilitate

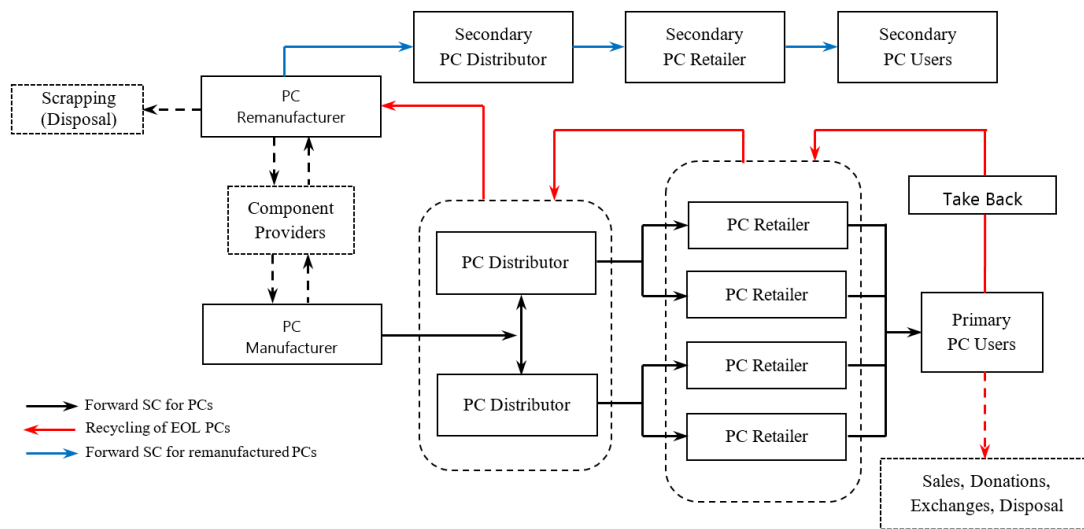

Figure 3.1: Computer recycling supply chain (Govindan and Popiuc, 2014)

the donation of used IT equipment. For instance, PC Re-builders & Recyclers (PCRR) in Chicago provide donated refurbished PCs to Illinois schools and non-profit organizations at very low cost and only charges for the refurbishing (Rapp, 2016).

- **Secondary market for customers:** there are many small and medium enterprises involved in the business of used computers like Computer Renaissance franchise in North America which owns 110 stores (Hsieh, 2010; Kuehr et al., 2003). Individuals can go through these resellers to resell their used computers or purchase a used computer.

As we discussed earlier, remanufacturing begins with the take-back of end-of- life cores (computers) from customers to the remanufacturing facility where they undergo following activities:

- **Inspection:** It is assessing basic information (Model, type and year of manufacture) and quality of each computer by determining the amount of physical damage and the level of functionality. Based on the inspected computer's quality, an appropriate option will be assigned: remanufacturing or disassembly to salvage useful parts from them.
- **Computer remanufacturing:** The computer with a remanufacturing option is

Table 3.2: Computer remanufacturing steps (Stats, 2015)

Step	Description
Sanitization	Sticker removal, panel and exterior cleaning. High pressure air is sprayed to remove dust
Data wipe	Hard drives are either destroyed or data is thoroughly removed to meet the Department of Defense recommended standards
Repairs, replacement & reassembly	Repairing the parts or replacing them with new parts
Testing and quality control	Original Equipment Manufacturer (OEM) software used to test CPU, RAM and HDD to give optimal computing power. All tests are verified by hardware test log which are printed and attached to all computers.
Cosmetic repairs	Used PCs usually have cosmetic blemishes (scratches, dents, etc.).Dented metallic parts are fixed as well as removal of scratches and cosmetic blemishes in order to restore it to like-new quality.
Software installation and licensing	Windows and Microsoft Office installed. Windows and MS Office licenses are provided by Microsoft at discount prices for registered refurbishers.
Packaging and shipping	The device is re-packaged as refurbished item and shipped to the customers.

put in remanufacturing site to be restored to an “as new condition”. This process involves various steps, which are listed in Table 2.

- **Computer disassembly:** The computer with a disassembly option is disassembled based on bill of material which indicates the quantity of parts that can be obtained after recovery process. The useful parts will be stocked as replacement parts.
- **Part refurbishing:** It is removing contamination such as dirt and dust, return parts to at least as new performance specification and testing for fitness.

All computer remanufacturing operations have the same basic structure but the order in which these activities are undertaken may differ between different types or in different facilities.

### 3.4 Problem definition and mathematical formulation

In modern day business climate, the businesses and manufacturers remain competitive by wide spread use of remanufacturing process in order to maximize the value from returns at the end of their service life. However, the scarcity of time and resources

have resulted in the need to outsource the remanufacturing businesses to third party remanufacturers (Kannan et al., 2017; Korugan et al., 2013). As we discussed earlier, the remanufacturing processes depend on type of the product as well as the industry, such as personal electronics, industrial electronics or automobile industries. But there are also a number of standard processes used in the remanufacturing process, also referred to as process characteristics such as core collection, disassembly, refurbishing, and re-assembly (Kim et al., 2006). The remanufacturing system modeled in this chapter is generalized for use across industry.

The remanufacturing process begins with the arrival of returns from end-users. The third-party remanufacturing facility often works with several OEMs, in which the process of used product recovery is relegated to the third-party remanufacturer. Upon receiving the used products, the remanufacturing third-party facility sends the cores collectively to a centralized location where their quality is inspected and graded on a scale of 0 to 1, 1 being the highest quality level. The OEMs then purchase the graded used product at a price that is a function of their quality grade. Ferguson et al. (2009) found that when a grading system is adapted prior to remanufacturing, profitability can increase regardless of the quality distribution. Finally, the cores are sorted in two categories; depending on whether they meet a set quality threshold. Those that meet the quality threshold are advanced to the remanufacturing site. Otherwise, the rest are sent to the disassembly site for salvaging or disposal site.

In the model, the returned products assigned to the remanufacturing site are set to restore to 'like-new' condition. The remanufacturing process may entail a disassembly with the addition of new parts/components as needed. The restored products are then stored in a product inventory where they are sold into the secondary market. At the disassembly site, the products are disassembled into their constituent parts following the product's bill of material of disassembly (provided by the OEM). Since not all disassembled parts are reusable and certain parts could have reached their end of life, remanufacturer covers the disposal (landfill or incineration) cost of any unsalvageable part. The remaining parts which are salvageable condition are cleaned, restored and added to the inventory of useful

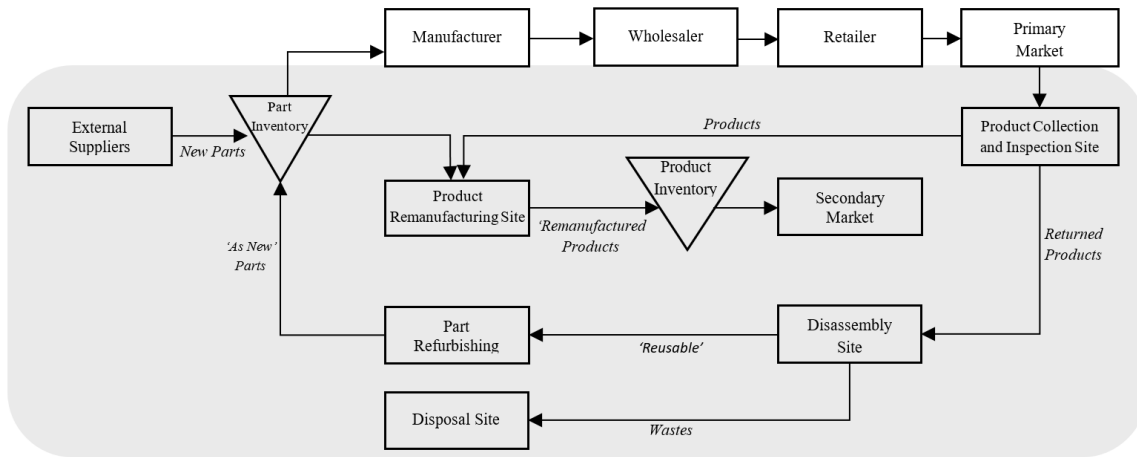

Figure 3.2: The remanufacturing system's conceptual framework, adopted from (Kim et al., 2006).

parts alongside new parts purchased from external supplies. Finally, the stored parts are sent the facility based on the company's production plan. The remanufacturing system's conceptual framework is depicted in Figure 3.2.

To maximize the total expected profit the remanufacturer needs to be agile enough to timely respond to the dynamic nature of the secondary market demand. At the same time, the remanufacturer has two options to acquire parts needed for the remanufacturing process; either to order new parts from an external supplier or utilize the inventory of refurbished parts. Thus, to achieve the maximum profit, the remanufacturer should determine the optimal quality and quantity of returns to accept into the remanufacturing site, the quantity of products that should be disassembled to parts and the quantity of new parts that should be ordered from the external supplier. These tactical decisions highly depend on the set quality and inventory capacity threshold. This multi-period, multi-product planning problem is modeled as a mixed integer non-linear programming (MINLP) model.

Model assumptions:

- The demand and return quantities are considered to be deterministic.
- The collected products are inspected on a first come first served basis and quality grading process is assumed to be very precise.

- Quality of returns  $\omega$  is assumed to have a beta prior distribution with density function:

$$f(\omega) = \frac{\Gamma(m+n)}{\Gamma(m)\Gamma(n)} \omega^{m-1} (1-\omega)^{n-1}. \quad 0 \leq \omega \leq 1 \quad (3.1)$$

The beta distribution is adopted because of its flexibility and prior use to model the proportion parameter (Ferguson et al., 2009; Law et al., 1991).

- The acquisition price and remanufacturing cost are quality dependent and they both increase linearly with increasing quality grade. There are diverse papers that addressed such a quality dependent relationship core acquisition price and remanufacturing cost, for instance, (Ferguson et al., 2009; Galbreth and Blackburn, 2010; Radhi and Zhang, 2016; Watanabe et al., 2013). Moreover, Radhi and Zhang (2016); Wei et al. (2015) assigned an acquisition cost for each return dependent on its quality, and is put forth that this pricing policy is better than setting a constant acquisition price for all returns or setting an acquisition price for each quality class.
- The facility includes three different inventories for returns, remanufactured products and refurbished/new parts as the production might exceed actual demand or to balance supply and demand in future periods. Additionally, cost of under-stocking is added to the model since not satisfying the demand may be beneficial.
- All remanufacturing, disassembly and refurbishing sites can process any product or part, though the capacity and cost may vary.
- A fixed rate is used for the cost of the safe disposal of unused materials and parts (paid to the disposal site). The number of disposed parts may not exceed the upper bound set by the facility which is subjected to environmental regulation according to environmental laws.
- All remanufacturing, disassembling and refurbishing set-up costs are above the zero with different idle costs.
- Inventory levels at the start of period 1 is 0.

### 3.4.1 Notations

#### Sets

$P = \{1, 2, \dots, P\}$  set of products;

$I = \{1, 2, \dots, I\}$  set of parts;

$T = \{1, 2, \dots, T\}$  set of time periods;

$S = \{1, 2, 3\}$  set of sites, where 1, 2, and 3 denote remanufacturing, disassembly, and refurbishing sites, respectively;

#### Parameters

$\gamma_{pt}$  estimated sales target for product  $p$  in period  $t$ ;

$D_{it}$  required quantity of part  $i$  in period  $t$ ;

$\hat{u}_p$  under-stocking cost for remanufactured product  $p$ ;

$\Phi_{pt}$  quantity of returned product  $p$  in period  $t$  from primary market;

$\Delta_s$  capacity of site  $s$ ;

$\delta, \hat{\delta}, \bar{\delta}$  inventory holding capacity for returned products, remanufactured products, and refurbished parts respectively;

$\hat{\rho}_{pi}$  number of part  $i$  from disassembling one unit of product  $p$ ;

$\bar{c}_i$  unit operation cost of refurbishing disassembled part  $i$ ;

$\dot{c}_p$  unit operation cost of disassembling returned product  $p$ ;

$\dot{\xi}_i$  unit disposal cost of disassembled part  $i$ ;

$V_p, V_i$  volume of one unit of product  $p$ , and part  $i$  respectively;

$h_p, \hat{h}_p$  unit holding cost of product  $p$  in period  $t$  for returned product, and remanufactured product respectively;

$\bar{h}_i$  unit holding cost of part  $i$  in period  $t$ ;

$C_s$  setup cost of site  $s$ ;

$\tilde{C}_s$  idle cost of site  $s$ ;

$\omega_p$  actual quality of returned product type  $p$  from primary market;

- $f_{\omega}(\cdot)_p$  PDF for the variables assigned for quality of product  $p$  returned from primary market;
- $F_{\omega}(\cdot)_p$  CDF for the variables assigned for quality of product  $p$  returned from primary market;
- $a_p$  unit acquisition, sorting and inspection cost of returned product  $p$  from primary market with the worst possible quality;
- $\alpha_p$  slope of acquisition, sorting and inspection cost vs. quality linear relationship for product type  $p$ ;
- $b_p$  remanufacturing cost assigned for returned product  $p$  from primary market with the worst possible quality;
- $\beta_p$  slope of remanufacturing costs vs. quality linear relationship;
- $\bar{\pi}_p$  unit market sales price of remanufactured product  $p$ ;
- $c_i$  unit purchase cost of part  $i$  from external suppliers;
- $\lambda_i$  upper bound of disposal rate for disassembled part  $i$ ;

#### *Decision variables*

- $\omega_{pt}^*$  optimal minimum required quality to accept product  $p$  to remanufacturing site in period  $t$ ;
- $x_{pt}$  remanufactured product  $p$  sales in period  $t$  to secondary market;
- $y_{it}$  quantity of purchased part  $i$  in period  $t$ ;
- $g_{pt}^-$  number of rejected product  $p$  and sent to disassembly site in period  $t$ ;
- $g_{pt}^+$  quantity of product  $p$  accepted into remanufacturing site in period  $t$ ;
- $\dot{q}_{it}$  quantity of disassembled part  $i$  in period  $t$ ;
- $\bar{q}_{it}$  quantity of refurbished part  $i$  in period  $t$ ;
- $q'_{it}$  quantity of disposed part  $i$  in period  $t$ ;



- $d_{pt}, \hat{d}_{pt}$  inventory level at the end of period  $t$  for returned product and remanufactured product  $p$  respectively;
- $\bar{d}_{it}$  inventory level at the end of period  $t$  for refurbished part  $i$ ;
- $\hat{z}_{pt}$  binary variable for setup of remanufacturing product  $p$  in period  $t$ ;
- $\dot{z}_{pt}$  binary variable for setup of disassembly product  $p$  in period  $t$ ;
- $\bar{z}_{it}$  binary variable for setup of refurbishing part  $i$  in period  $t$ ;

### 3.4.2 Optimization objective

Our objective is to maximize the total expected profit of the facility across all types of products and parts during the planning horizon. The profit is measured as the difference between the net revenue from remanufactured products and the costs, which include the acquisition and inspection cost of returns, purchasing cost of replacement parts from the external suppliers, inventory holding costs, under-stocking cost, remanufacturing processes cost and disposal cost. Note that the proposed model also maximize the net profit by saving the cost of remanufacturing process and increasing utilization of different sites by considering the operations cost, set-up cost and idle cost of each site. We next discuss the cost components of the model.

**Operational cost:** Consists of remanufacturing cost, product disassembly cost, part refurbishing cost, inventory holding cost at collection and inspection center, product and part inventories. The operational cost is mathematically represented by equation (3.2) using notations and parameters defined above as follows:

$$\begin{aligned} & \sum_{p=1}^P \sum_{t=1}^T \int_{\omega_{pt}}^1 [b_p - \beta_p \omega_p] \cdot g_{pt}^+ f_{\omega}(\omega_p)_p d\omega_p + \sum_{p=1}^P \sum_{t=1}^T g_{pt}^- \dot{c}_p + \sum_{i=1}^I \sum_{t=1}^T \bar{q}_{it} \bar{c}_i + \\ & \sum_{i=1}^I \sum_{t=1}^T q'_{it} \dot{\xi}_i + \sum_{p=1}^P \sum_{t=1}^T d_{pt} h_p + \sum_{p=1}^P \sum_{t=1}^T \hat{d}_{pt} \hat{h}_p + \sum_{i=1}^I \sum_{t=1}^T \bar{d}_{it} \bar{h}_i \end{aligned} \quad (3.2)$$

**Purchasing and under-stocking cost:** Consists of the returns acquisition and inspection cost, cost to purchase from the external suppliers and the total under-stocking cost, which is represented by equation (3.3).

$$\sum_{p=1}^P \sum_{t=1}^T \int_0^1 [a_p + \alpha_p * \omega_p] * \Phi_{pt} f_{\omega}(\omega_p)_p d\omega_p + \sum_{i=1}^I \sum_{t=1}^T y_{it} c_i + \sum_{p=1}^P \sum_{t=1}^T (\gamma_{pt} - x_{pt}) \hat{u}_p \quad (3.3)$$

**Set up and idle cost:** Includes set-up cost of remanufacturing, disassembly, refurbishing sites as well as their idle costs which is represented by equation (3.4).

$$\begin{aligned} & \sum_{p=1}^P \sum_{t=1}^T \hat{z}_{pt} C_1 + \sum_{p=1}^P \sum_{t=1}^T \dot{z}_{pt} C_2 + \sum_{i=1}^I \sum_{t=1}^T \bar{z}_{it} C_3 + \\ & \sum_{p=1}^P \sum_{t=1}^T (1 - \hat{z}_{pt}) \tilde{C}_1 + \sum_{p=1}^P \sum_{t=1}^T (1 - \dot{z}_{pt}) \tilde{C}_2 + \sum_{i=1}^I \sum_{t=1}^T (1 - \bar{z}_{it}) \tilde{C}_3 \end{aligned} \quad (3.4)$$

**Revenue:** Generated by selling remanufactured products into the secondary market. The revenue of the remanufacturing facility is calculated by Equation(3.5).

$$\sum_{p=1}^P \sum_{t=1}^T x_{pt} \bar{\pi}_p \quad (3.5)$$

The overall expected profit is determined by as the difference between (3.5) and the total summation of (3.2), (3.3) and (3.4). Therefore, the profit function should be as follow:

$$\begin{aligned}
& \sum_{p=1}^P \sum_{t=1}^T x_{pt} \bar{\pi}_p - \left( \sum_{p=1}^P \sum_{t=1}^T \int_{\omega_{pt}}^1 [b_p - \beta_p \omega_p] * g_{pt}^+ f_{\omega}(\omega_p)_p d\omega_p + \sum_{p=1}^P \sum_{t=1}^T g_{pt}^- \dot{c}_p + \right. \\
& \quad \left. \sum_{i=1}^I \sum_{t=1}^T \bar{q}_{it} \bar{c}_i + \sum_{i=1}^I \sum_{t=1}^T q'_{it} \dot{\xi}_i + \sum_{p=1}^P \sum_{t=1}^T d_{pt} h_p + \sum_{p=1}^P \sum_{t=1}^T \hat{d}_{pt} \hat{h}_p + \right. \\
& \quad \left. \sum_{i=1}^I \sum_{t=1}^T \bar{d}_{it} \bar{h}_i + \sum_{p=1}^P \sum_{t=1}^T \int_0^1 [a_p + \alpha_p * \omega_p] * \Phi_{pt} f_{\omega}(\omega_p)_p d\omega_p + \sum_{i=1}^I \sum_{t=1}^T y_{it} c_i + \right. \\
& \quad \left. \sum_{p=1}^P \sum_{t=1}^T (\gamma_{pt} - x_{pt}) \hat{u}_p + \sum_{p=1}^P \sum_{t=1}^T \hat{z}_{pt} C_1 + \sum_{p=1}^P \sum_{t=1}^T \dot{z}_{pt} C_2 + \sum_{i=1}^I \sum_{t=1}^T \bar{z}_{it} C_3 + \right. \\
& \quad \left. \sum_{p=1}^P \sum_{t=1}^T (1 - \hat{z}_{pt}) \tilde{C}_1 + \sum_{p=1}^P \sum_{t=1}^T (1 - \dot{z}_{pt}) \tilde{C}_2 + \sum_{i=1}^I \sum_{t=1}^T (1 - \bar{z}_{it}) \tilde{C}_3 \right) \quad (3.6)
\end{aligned}$$

### 3.4.3 Constraints

The objective function is subject to various constraints. Using the notations, parameters and variables defined in section 3.4.1 the constraints are:

Returns:

$$g_{pt}^+ \leq \int_{\omega_{pt}}^1 \Phi_{pt} f_{\omega}(\omega_p)_p d\omega_p \quad \forall p, \text{ and } t = 1, \dots, T \quad (3.7)$$

Constraint (3.7) makes sure that the remanufacturing site will only process collected returns from primary market that have been accepted which the quantity is equivalent to  $\int_{\omega_{pt}}^1 \Phi_{pt} f_{\omega}(\omega_p)_p d\omega_p$ .

$$g_{pt}^- \leq \int_0^{\omega_{pt}} \Phi_{pt} f_{\omega}(\omega_p)_p d\omega_p \quad \forall p, \text{ and } t = 1, \dots, T \quad (3.8)$$

In period  $t$ , quantity of returns from primary market that have not met the minimum quality grade or exceeded the remanufacturing site capacity are sent to the disassembly site.

$$\dot{q}_{it} = \sum_{p=1}^P \dot{\rho}_{pi} g_{pt}^- \quad \forall i, \text{ and } t = 1, \dots, T \quad (3.9)$$

$$\sum_{t=1}^T q'_{it} \leq \lambda_i \sum_{t=1}^T \dot{q}_{it} \quad \forall i, \text{ and } t = 1, \dots, T \quad (3.10)$$

$$\bar{q}_{it} + q'_{it} = \dot{q}_{it} \quad \forall i, \text{ and } t = 1, \dots, T \quad (3.11)$$

Constraint (3.9) calculates the quantity of each part after disassembling products using the bill of material at the disassembly site. Constraint (3.10) ensures that the company quantity of disposed parts do not exceed  $\lambda_i\%$  of disassembled parts, where  $\lambda_i$  is pre-specified. Equation (3.11) represents the balance equation for refurbished parts, disposed parts and disassembled parts.

$$g_{pt}^+ \leq \Delta_1 \quad \forall p, \text{ and } t = 1, \dots, T \quad (3.12)$$

$$g_{pt}^- \leq \Delta_2 \quad \forall p, \text{ and } t = 1, \dots, T \quad (3.13)$$

$$\bar{q}_{it} \leq \Delta_3 \quad \forall i, \text{ and } t = 1, \dots, T \quad (3.14)$$

Constraints (3.12)-(3.14) ensures that quantity of products or parts sent to remanufacturing, disassembly and refurbishing sites do not exceed the capacity of those sites. Inventory balance equation:

$$\Phi_{pt} + d_{p,t-1} = g_{pt}^+ + g_{pt}^- + d_{pt} \quad \forall p, \text{ and } t = 1, \dots, T \quad (3.15)$$

$$g_{pt}^+ + \hat{d}_{p,t-1} = x_{pt} + \hat{d}_{pt} \quad \forall p, \text{ and } t = 1, \dots, T \quad (3.16)$$

$$y_{it} + \bar{q}_{it} + \bar{d}_{i,t-1} = \bar{d}_{it} + D_{it} \quad \forall i, \text{ and } t = 1, \dots, T \quad (3.17)$$

Equations (3.15)-(3.17) refers to the inventory balance equations for collected returns, remanufactured products and refurbished parts respectively. Inventory constraints:

$$\sum_{p=1}^P V_p d_{pt} \leq \delta \quad \forall p, \text{ and } t = 1, \dots, T \quad (3.18)$$

$$\sum_{p=1}^P V_p \hat{d}_{pt} \leq \hat{\delta} \quad \forall p, \text{ and } t = 1, \dots, T \quad (3.19)$$

$$\sum_{i=1}^I V_i \bar{d}_{it} \leq \bar{\delta} \quad \forall i, \text{ and } t = 1, \dots, T \quad (3.20)$$

Constraints (3.18), (3.19) and (3.20) sets the maximum capacity on the total inventory of returned products, remanufactured products and refurbished parts.

Sales quantities:

$$x_{pt} \leq \gamma_{pt} \quad \forall p, \text{ and } t = 1, \dots, T \quad (3.21)$$

Constraint (3.21) ensures that quantity of remanufactured products sold into the secondary market do not rise above the estimated sales target in any period  $t$ .

Set-up constraints and binary variables:

$$g_{pt}^+ \leq M \cdot \hat{z}_{pt} \quad \forall p, \text{ and } t = 1, \dots, T \quad (3.22)$$

$$g_{pt}^- \leq M \cdot \dot{z}_{pt} \quad \forall p, \text{ and } t = 1, \dots, T \quad (3.23)$$

$$\bar{q}_{it} \leq M \cdot \bar{z}_{it} \quad \forall i, \text{ and } t = 1, \dots, T \quad (3.24)$$

$$\hat{z}_{pt} \in \{0, 1\} \quad \forall p, \text{ and } t = 1, \dots, T \quad (3.25)$$

$$\dot{z}_{pt} \in \{0, 1\} \quad \forall p, \text{ and } t = 1, \dots, T \quad (3.26)$$

$$\bar{z}_{it} \in \{0, 1\} \quad \forall i, \text{ and } t = 1, \dots, T \quad (3.27)$$

Constraints (3.22)-(3.24) are set-up constraints for remanufacturing site, disassembly site and refurbishing site and Constraints (3.25)-(3.27) enforce the binary restrictions.

Non-negativity constraints:

$$x_{pt} \geq 0, g_{pt}^+ \geq 0, g_{pt}^- \geq 0 \quad \forall p, \text{ and } t = 1, \dots, T \quad (3.28)$$

$$y_{it} \geq 0, \dot{q}_{it} \geq 0, \bar{q}_{it} \geq 0, q'_{it} \geq 0 \quad \forall i, \text{ and } t = 1, \dots, T \quad (3.29)$$

Constraints (3.28) and (3.29) pose the non-negativity condition on decision variables.

$$0 \leq \omega_{pt} \leq 1 \quad \forall p, \text{ and } t = 1, \dots, T \quad (3.30)$$

We have also an additional constraint (3.30) to ensure that the optimal quality is meaningful ( $0 \leq \omega_{pt} \leq 1$ ). Based on the constraint, if the optimal minimum quality  $\omega_{pt}$  is equal to 1, the facility does not take any returns in period  $t$ . In this case,  $\int_{\omega_{pt}}^1 \Phi_{pt} f_{\omega}(\omega_p)_p d\omega_p = 0$  for Beta distribution.

## 3.5 Numerical illustration of model application

### 3.5.1 Case study

We apply the mathematical model in the previous section to assess the impacts of quality uncertainty, non-uniform volume of returns, cost of the remanufacturing process and inventory capacity of each site on the profitability of the facility in a multi-period production planning context. A small dataset is prepared to facilitate the analysis and reflect the real business environment at a third-party PC remanufacturer. For proprietary purposes, the name of the third-party remanufacturer will be withheld (refer to Figure 3.2). The company's goal is to satisfy customers demands, while keeping the operational costs to a

Table 3.6: Remanufacturing computer configuration example

		Computer model type	
		'PC 1'	'PC 2'
Part model type	Main-board	MB1	MB2
	RAM	RAM1	RAM2
	HDD	HDD1	HDD2
	DVD	DVD1	DVD2
	Cable	CAB1	CAB2

Table 3.7: The number of parts for disassembling a single product  $\hat{\rho}_{pi}$

	Main-board	RAM	HDD	DVD	Cables
'PC 1'	1	2	1	0	1
'PC 2'	1	2	1	1	2

minimum, as well as meeting the economic targets while adhering to environmental regulations. Furthermore, computer products vary greatly, so the company must be able to accommodate both current and future variations along with different computer models. Therefore, in this work we propose a model that is adaptable enough to accommodate facilities with such product diversity.

In order to verify the proposed model and provide detailed production plan (schedule) the company, we consider the detailed structure of two types of computer models herein referred to as 'PC 1' and 'PC 2', which consist of 5 main part types, as shown in Table 3.6 and six time-periods for the planning horizon. Furthermore, similar to study by Cho et al. (2017), the assumption is made that the part types are interchangeable for use across multiple computer model types. For instance, 'MB1' can be used in the two computer models ('PC 1' and 'PC 2'). The Bill-of-material (BOM) of each computer model which shows the number of parts after a single product is disassembled is indicated in Table 3.7. Scenarios of varying parameters and set values including beta distribution parameters, acquisition price and remanufacturing costs are considered in the analysis (as depicted in Figure 3.3).

Computer model 'PC 2' is a newer version with high demand in the secondary market compared to the computer model 'PC 1'. As a result, the margin for the remanufacturing of Computer model 'PC 2' is relatively higher than that of 'PC 1'. While exact quantities

Table 3.8: Returns forecast data for 6 months  $\Phi_{pt}$ 

Months	T1	T2	T3	T4	T5	T6
'PC 1'	513	416	548	512	423	530
'PC 2'	564	538	552	597	522	641

of returns for the two computer models may vary somewhat from time to time, monthly returns forecasts for the two models have been generated from past data of the company and sales data of those models in primary market while accounting for seasonality and trend effects. The predicted number of collected products that will be stored in the collection and inspection site at each month are presented in Table 3.8. The collection site cannot hold more than 300 products of any model for every month. Moreover, the remanufacturing site, disassembly site and refurbishing site have limited capacities in terms of the number of units that can be processed every month. Table 3.9 provides the data related to estimated sales of the remanufactured products, cost to disassemble products and capacity at each site. The part requirement of the facility during the next six-month months and data related to refurbished parts are presented in Table 3.10.

The set-up cost and the idle cost of all sites are set to be \$1000 and \$200, respectively. Due to environmental regulation, the disposal rate of disassembled parts cannot exceed the 0.2 of all disassembled parts at each period. As discussed before, computer model 'PC 2' is a newer version with high demand in the secondary market, consequently, its unit sales price is higher than that of computer model 'PC 1'. In our analysis, the secondary market unit sales prices is set to be \$229 and \$399 for two computer models. The remanufacturing cost and acquisition cost are quality dependent, as assumed by Ferguson et al. (2009); Radhi and Zhang (2016). Acquisition price and remanufacturing cost vs. quality have a linear relationship used in the numerical example are shown in Figure 3.4.

Similar to the study by Radhi and Zhang (2016), the under-stocking cost is the lost profit that is determined based on the cost related to returns with mid-quality grade. We refer readers to Galbreth and Blackburn (2006) for more complex methods in which the under-stocking and over-stocking costs are calculated as a function of the total reman-



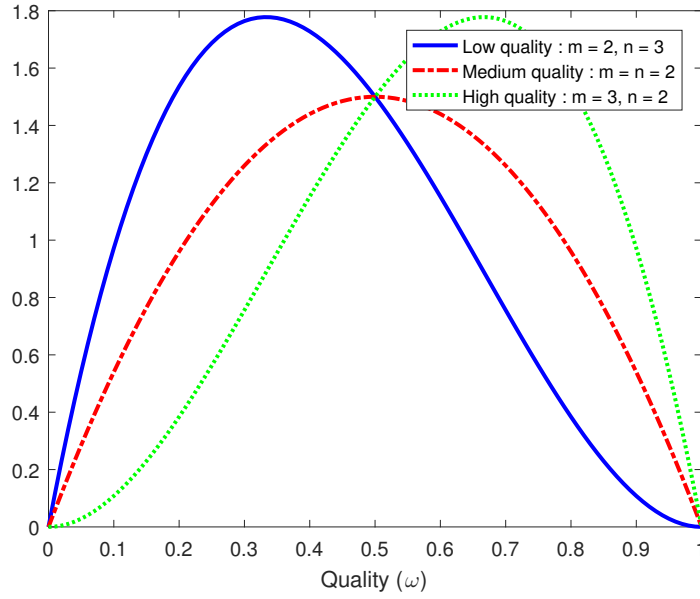

Figure 3.3: Different Quality levels following beta distribution using three parameter settings

ufacturing cost, customer demand and the optimum purchased return quantity. In this paper, the under-stocking cost for two computer models are \$36 and \$115 respectively as shown using the formula as below:

$$\hat{u} = \text{Sales price} - \text{total cost of return at mid-quality grade } (q = 0.5) \quad (3.31)$$

In our illustration, the product and part inventory capacities are pre-determined and limited to 150 and 200 units, respectively for all types collectively. An analysis for the effects of quality-based classification of returned products is carried out for different quality level specified in Figure 3.3. The other cost parameters in the base scenario are varied one at a time to analyze their impact on the optimal decisions (as shown in Figure 3.4). The performance impacts are assessed in terms of the optimal required minimum quality and profitability. We discuss the solution approach and how to solve the model efficiently in the next section.

Table 3.9: Estimates sales target for remanufactured product  $p$  in period  $t$  ( $\gamma_{pt}$ )

Months	T1	T2	T3	T4	T5	T6	Cost to disassemble(\$)	Capacity of remanufacturing site	Capacity of disassembly site
'PC 1'	364	321	215	261	305	273	30	300	250
'PC 2'	520	480	473	582	472	456	40	550	50

Table 3.10: Required quantity of part  $i$  in period  $t$  ( $D_{it}$ ), cost of refurbishing(\$), capacity of refurbishing site and purchasing price(\$) of parts

Months	T1	T2	T3	T4	T5	T6	Cost to refurbish(\$)	Capacity of refurbishing site	Refurbished parts purchasing price(\$)
Main-board	234	272	346	387	350	450	7	250	70
RAM	656	557	490	575	599	667	4	500	40
HDD	145	150	173	169	150	150	2.5	250	25
DVD	148	186	138	104	189	115	1.6	100	16
Cables	301	364	315	354	307	276	0.4	300	4

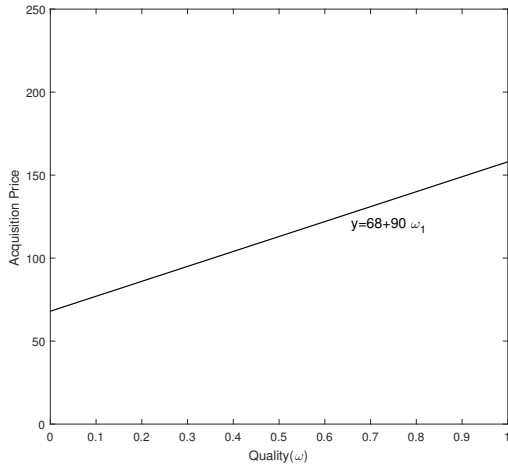

(a)

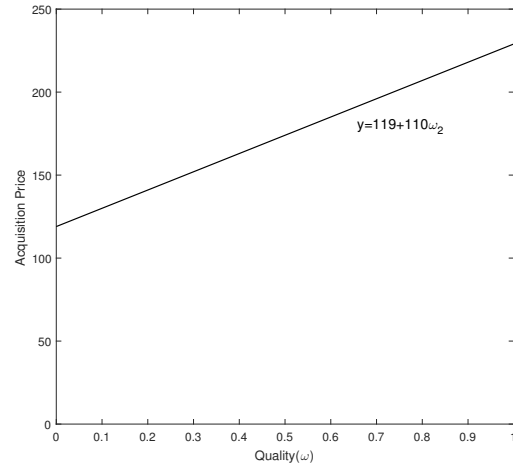

(b)

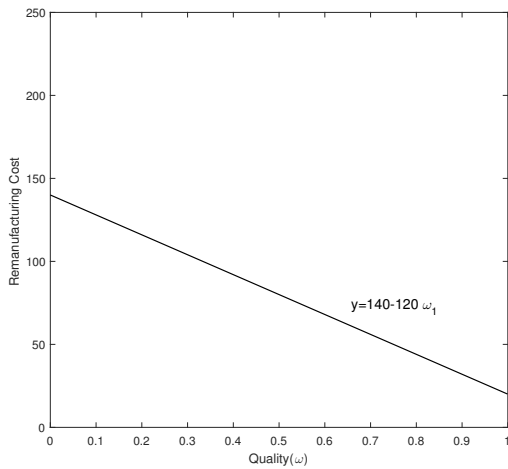

(c)

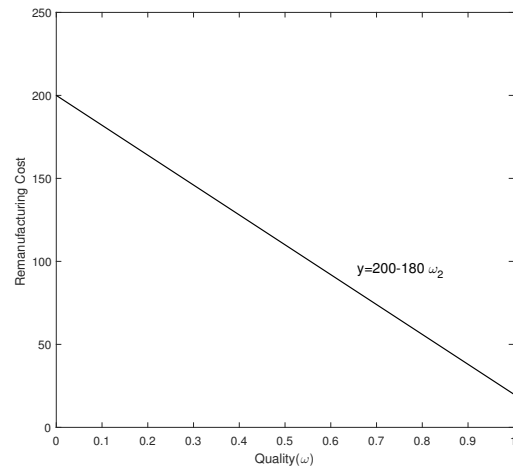

(d)

Figure 3.4: Acquisition price and remanufacturing cost of two different products for the numerical example. (a) shows the acquisition price vs. quality for 'PC 1', (b) shows the acquisition price vs. quality for 'PC 2', (c) shows the remanufacturing cost acquisition price vs. quality for 'PC 1' and (d) shows the remanufacturing cost acquisition price vs. quality for 'PC 2'

### 3.5.2 Solution approach

As it was described earlier, the random variable  $\omega$  corresponds to the quality grades and has a Beta distribution whose parameters are exponents which control the shape of the distribution. Thus, the proposed model in Section 3.4 is nonlinear. To solve the model efficiently, we discretize the variable  $\omega$  into 0.01 increments. Let  $\hat{\omega}_{pt}^j$  be binary variable denoting the  $j^{th}$  discretized increment between 0 and 1, where  $j \in \{0, 1, 2, \dots, 100\}$ . That is,  $\hat{\omega}_{pt}^j$  corresponds to the value of  $0.01j$  for  $\omega_{pt}$ . Note that for any product at any time period exactly one  $\hat{\omega}_{pt}^j$  gets positive value, i.e.,

$$\sum_{j=0}^{100} \hat{\omega}_{pt}^j = 1, \quad \forall p, \text{ and } t = 1, \dots, T \quad (3.32)$$

For example, given the high quality for returned products, i.e.,  $B(2, 3)$ , the first part of equation (3.2) that includes  $\omega_{pt}$  is written as follows:

$$\sum_{p=1}^P \sum_{t=1}^T g_{pt}^+ \cdot b_p \cdot \left( 3\omega_{pt}^4 - 4\omega_{pt}^3 + 1 \right) - \beta_p \cdot g_{pt}^+ \cdot \left( 2.4\omega_{pt}^5 - 3\omega_{pt}^4 + 0.6 \right) \quad (3.33)$$

which is a nonlinear equation. Now, using proposed discretization procedure, the above equation is re-written as follows:

$$\begin{aligned} & \sum_{p=1}^P \sum_{t=1}^T g_{pt}^+ \cdot b_p \cdot \left( 3 \left( \sum_{j=0}^{100} \hat{\omega}_{pt}^j \cdot j \cdot 10^{-2} \right)^4 - 4 \left( \sum_{j=0}^{100} \hat{\omega}_{pt}^j \cdot j \cdot 10^{-2} \right)^3 + 1 \right) - \\ & \beta_p \cdot g_{pt}^+ \cdot \left( 2.4 \left( \sum_{j=0}^{100} \hat{\omega}_{pt}^j \cdot j \cdot 10^{-2} \right)^5 - 3 \left( \sum_{j=0}^{100} \hat{\omega}_{pt}^j \cdot j \cdot 10^{-2} \right)^4 + 0.6 \right) \end{aligned} \quad (3.34)$$

Note that by using the proposed discretization, the model turns into a quadratic mixed integer programming (QMIP) problem that is solvable using commercial solvers such as IBM ILOG CPLEX.

### 3.5.3 Solution analysis and implications

The results of the developed model for the base scenario (high quality level for both product types) are discussed in this section using the numerical example provided in Section 3.5.1. In the next section, We discuss how quality of returns, minimum required quality grade, capacity of each site and other cost parameters impact the performance of the remanufacturing facility.

Table 3.11 represents the optimal minimum quality grade to accept product  $p$ , as well as the percentage of returns accepted to go to the remanufacturing site in each period. The table shows that lower percentage of 'PC 1' goes to the remanufacturing site, as a result of low demand for 'PC 1' relative to 'PC 2' as shown in Table 3.9. 'PC 1' is mostly used to response to demand of refurbished parts. During the six-month period, the minimum acceptance quality grade, varies depending on the returns and demand quantities of products and parts, and the cost to remanufacture. Table 3.12 represents the product quantities that have been rejected in inspection stage and sent to disassembly site. The percentage of that products go to each facility is illustrated in Figure 3.5. Note that some products remain in the returns product inventory at the end of the time horizon.

The monthly sales of the two PCs are shown in Table 3.13. During periods 1 and 2, there was a shortage of 'PC 1' that is mostly because of the capacity of the remanufacturing site for 'PC 1' but in other periods, the demand is satisfied by using carried-over inventory from previous periods. The number of parts refurbished after disassembly is given in Table 3.14. The shortage of required parts is purchased from the the external suppliers as presented in Table 3.15. Also, there is not required to purchase HDD as disassembled parts suffice the demands and the remanufacturer required to purchase all required amount of DVDs at period 5 and 6 from external suppliers.

There is mostly left-over parts at the end of each period because of the variability in the required parts for each products as per its BOM. The optimal number of parts that should be disposed is determined by taking into account the number of disassembled parts, disposal cost, and the upper bound of disposal rate. For example, 105,17,177 and 60 units of RAM are disposed during period 1 to 4 respectively.

Table 3.11: Optimal minimum quality and percentage of returns accepted for remanufacturing

Months	T1	T2	T3	T4	T5	T6
Optimal minimum quality to accept product $p$ to remanufacturing site in period $t$ ( $\omega_{pt}^*$ )						
'PC 1'	0.56	0.48	0.59	0.56	0.53	0.58
'PC 2'	0.29	0.32	0.3	0.3	0.31	0.47
The percentage of returns accepted for remanufacturing						
'PC 1'	59%	71%	54%	59%	64%	55%
'PC 2'	92%	90%	91%	91%	90%	73%

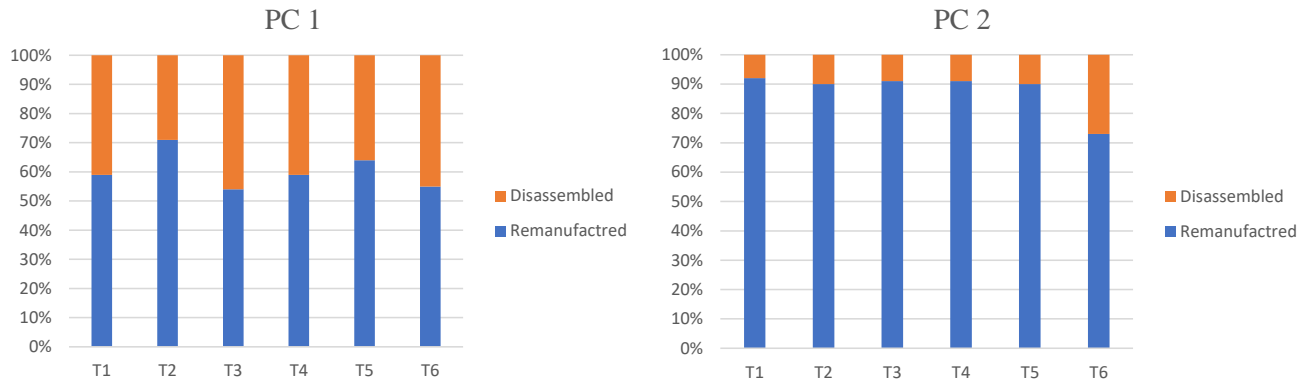

Figure 3.5: Percentage of products go to remanufacturing and disassembly sites

Table 3.12: Number of rejected product  $p$  in period  $t$  and sent to disassembly site ( $g_{pt}^-$ )

Months	T1	T2	T3	T4	T5	T6
'PC 1'	207	117	250	201	151	228
'PC 2'	43	50	0	49	0	0

Table 3.13: Sales of remanufactured product  $p$  in period  $t$  to the secondary market ( $x_{pt}$ )

Months	T1	T2	T3	T4	T5	T6
'PC 1'	300	298	215	261	305	273
'PC 2'	520	480	473	582	472	456

Table 3.14: Number of refurbished part  $i$  in period  $t$  ( $\bar{q}_{it}$ )

Months	T1	T2	T3	T4	T5	T6
Main-board	250	167	250	250	151	228
RAM	500	334	500	500	302	456
HDD	145	150	173	190	151	228
DVD	43	50	0	49	0	0
Cables	293	217	250	299	0	228

Table 3.15: Number of purchased part  $i$  in period  $t$  ( $y_{it}$ )

Months	T1	T2	T3	T4	T5	T6
Main-board	0	89	96	137	199	222
RAM	156	223	0	65	297	211
HDD	0	0	0	0	0	0
DVD	105	136	138	55	189	115
Cables	8	147	65	55	307	48

### 3.5.4 Sensitivity analysis

We discuss how quality of returns, minimum required quality grade, capacity of sites and other cost parameters impact the performance of the remanufacturing facility. We limit our discussion to the cases which provide interesting insights. Since our findings are predicated on the numerical values of the parameters, the insights are suggestive rather than conclusive. In a given context, appropriate parameter values can be used for deriving useful insights using the proposed model. The managerial implications of our findings are discussed later.

It is intuitive that the minimum acceptance quality grade in the remanufacturing site would be higher when the quality of returns is higher. Figure 3.6 demonstrated the optimal minimum required quality grades for the two product types in a six-month period. The higher optimal minimum required quality for ‘PC 1’ means that a higher percentage of ‘PC 1’ goes into the disassembly site to fulfill the demand for parts. Note that the minimum required quality is also depend on the capacity of sites, inventory level, different cost parameters and finally upper bound of disposal rate.

When each site reaches its capacity limit the products may be stored in the inventory or sent to other sites thus potentially increasing the profit of remanufacturing facility. For example, if remanufacturing sites reaches its capacity the returns may be stored in product collection inventory or sent to disassembly site depending on parts demands or cost of the inventory. Figure 3.7 demonstrates the effect of remanufacturing capacity on profit of the facility. The vertical axis of the figure plots the percentage change in profit and the vertical axis plots is different quality levels for returns. It is observed that increasing remanufacturing site capacity has the highest impact on profit if returns

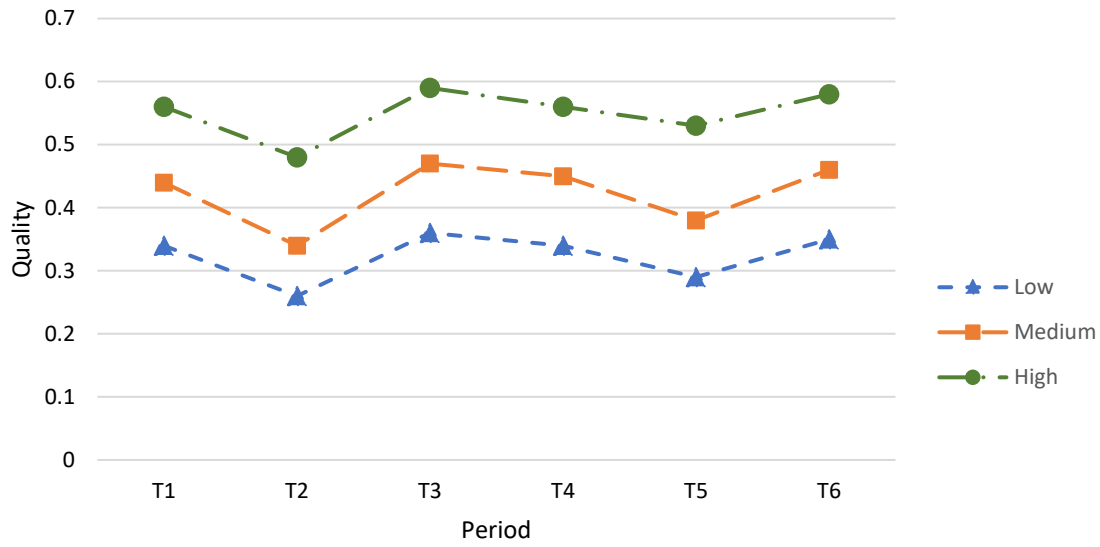

(a) PC 1

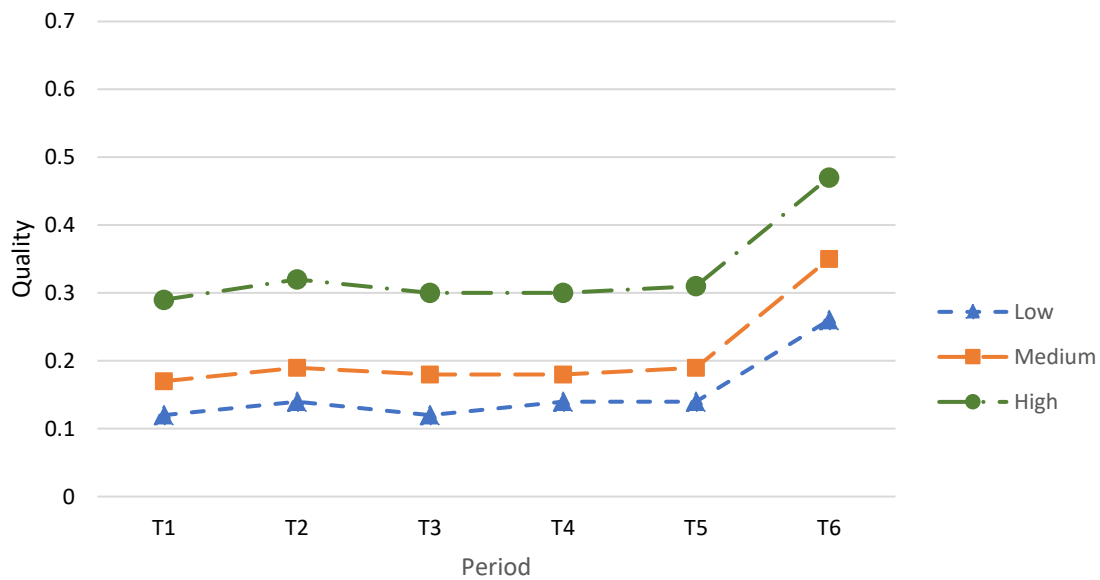

(b) PC 2

Figure 3.6: Optimal minimum quality for different quality levels for (a) 'PC 1' and 'PC 2'

have high quality, and decreasing the capacity has the highest impact if returns have low quality.

As discussed in Section 3.4, the number of disposed parts may not exceed the upper bound set by the facility which is subject to environmental regulations and laws. In



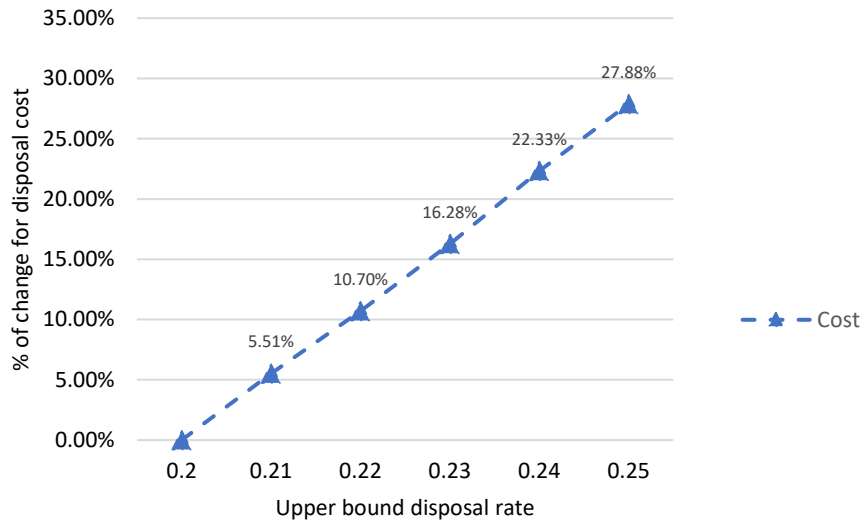

Figure 3.7: Effect of remanufacturing site capacity on profit

addition, it costs the facility to dispose the parts. Figure 3.8 describes how the disposal cost and profit of the facility change by increasing upper bound disposal rate. In our numerical example, as upper bound disposal rate increases the profit will increase. The increase in profit is encouraged by allowing the facility to dispose more parts and saving the cost of inventory and refurbishing more parts. These results could be varied for different problems.

### 3.6 Conclusion

This study focused on the optimal disposition of end-of-life product returns. The emphasis is on modeling parameters that illustrate the benefits of recovery and recycle as alternatives to the often expensive EOL product management by disposal. This study's main contribution is the development of an optimization model for the integrated production planning and inventory control of a third party remanufacture, while satisfying the demand from the secondary market. The proposed model incorporates the impacts of quality uncertainty on procurement, remanufacturing, disassembling, salvaging and stocking of used products for multiple periods of time. While few researchers have been



(a) Cost

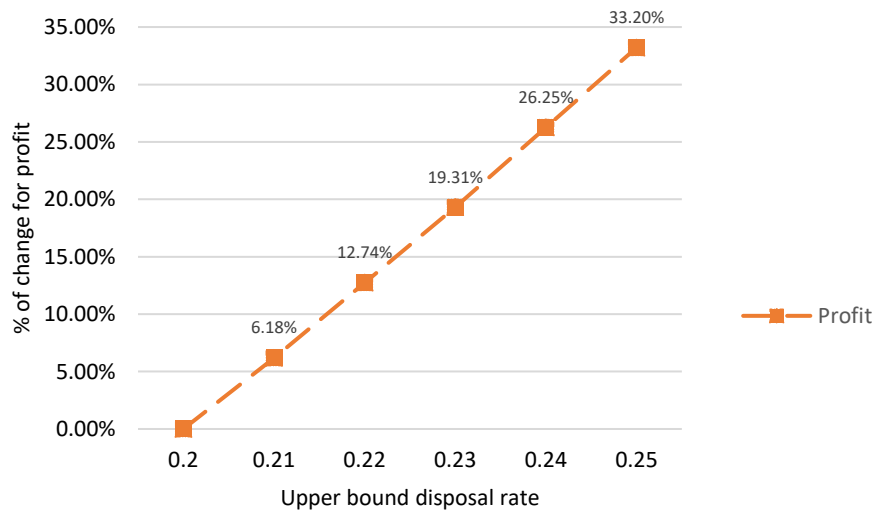

(b) Profit

Figure 3.8: Effect of disposal rate on disposal cost and profitability

conducted that look into determining an EOL option for a remanufacturing production planning and control, to our knowledge, none of the previous work have considered a combination of multiple EOL options for returned products and parts. There are also few works related to EOL product remanufacturing issues that includes quality uncertainty in multi-product production planning in capacitated remanufacturing in regards to long-term planning.

The need for a multi-product, multi-period production planning that reflects the real-world concerns of a remanufacturing firms such as the one that motivated this study, is real, as it addresses the impact of returns quality on the choice of EOL product management alternatives. The study also addressed several remanufacturing attributes such as returns acquisition price, the cost to remanufacture, inventory capacity and holding costs, and the non-uniform rate of returns and secondary market demands.

The proposed model assists the operation managers to determine the best route for each returned product or disassembled part, and the appropriate quantity of parts purchased from external suppliers in order to maximize profits. The numerical analysis indicate that minimum acceptance quality threshold is dependent on the capacity of sites, inventory level, varying cost parameters and the upper bound of disposal rate. The study also evaluates the other operational consequences (e.g. capacity of the facility) in such a remanufacturing setting. Specifically, the sensitivity analysis presented offers the following managerial insights:

- The profit is less in the absence of quality grading of returns and disposition decisions based on the quality.
- The model involves a complex trade-off between different cost parameters, site capacities, inventory size in a multi-product, multi-part, multi-period context which may not justify complete fulfillment of products, sales targets, or parts demand for economic reasons.
- In the considered remanufacturing setting, the products with lower demand are used to mostly response to demand of refurbished parts even if the quality is higher.

However, this decision may vary for different settings.

- The 3% increase in remanufacturing site capacity has the highest impact on profit if returns have high quality and decreasing the capacity by 3% has the highest impact on profit if returns have low quality. This result may also vary for different settings.
- The considered remanufacturing facility in this study is more profitable with a higher bound disposal rate. The increase in profit is encouraged by allowing the facility to dispose more parts and saves the cost of inventory and refurbishing more parts. These results could be varied for problems with different problems.

This study highlights the importance of quality grading in disposition decision in remanufacturing facilities. It recommends that operation managers should deploy this practice to ensure that they acquire products with higher quality and lower cost to re-manufacture to maximize the profit, while meeting environmental regulations. Though the case study was motivated by a PC remanufacturing facility, the proposed approach for disposition decision could be useful for other remanufacturing industries.

---

## Chapter 4

### Research Contributions and Future Research

This dissertation focused on decision making for capacitated reverse logistics networks with quality variations. Reverse logistics network business, strategic and tactical decisions are included by uncertainties that arise from the quality and quantity of returned product in the face of facility constraints. This dissertation incorporates two publications that addressed two problems in the remanufacturing systems' domain, namely, production planning and inventory control, and allocation of EOL products into different recovery process sites.

#### 4.1 Research Contributions

The major contributions of this dissertation that are embodied in Chapters 2 and 3 are summarized as follows:

- **Development of an optimal decision making model for a remanufacturing system:**

The model presented in Chapter 2 was motivated by the quest of the operation managers at a partner remanufacturing facility to improve managerial operational and tactical decisions. The considered remanufacturing system has a limited inventory capacity of recoverable returns and there's a constant demand to be met. To analyze the impact of the inventory and returns quality in the system's status, the problem was formulated as a continuous time Markov chain. The Matrix-Geometric solution methodology was applied to find the optimal disposition policy. The developed optimization model solution provides the optimal recoverable products inventory capacity and the corresponding return products acceptance quality threshold.

- **Managerial insights for the optimal decision making model for a remanufacturing system:**

The extensive numerical study and sensitivity analysis in Chapter 2 resulted in the insight that for smaller recoverable product inventories, variations in the return arrivals and quality of recoverable products have an impact on the customer order completion delay due to periodic process starvation. When these variabilities are incorporated into the decision process, the remanufacturer is able to absorb the process dynamics for larger recoverable inventories. As the inventory increases, the remanufacturer chooses to increase the minimum required quality grade in order to ensure adequate recoverable products in inventory with lower cost of remanufacture. We also found that if a remanufacturer has made decisions regarding the recoverable product inventory size and the minimum required quality grade, the existing system configuration may need to be changed if the demand rate changes. Finally, we concluded that it is vital for the remanufacturer to understand the expected demand level, the supplier's ability to provide recoverable products to remanufacture and the optimum (i.e. minimum) returns quality grades to accept so as to maximize the profit.

- **Developing a general framework for a third party remanufacturer for product EOL decisions:**

The work presented in Chapter 3 incorporate a multi-product, multi-period production planning horizon for facilities that have multiple recovery pathways. We proposed a mixed integer non-linear programming model (MINLP) for the integrated production planning. The solution methodology involves a discretization process that turned the problem into a quadratic mixed integer programming (QMIP) problem. We later applied the model to determine the optimum minimum required quality grade to accept into the remanufacturing facility and the quantity of parts purchased from external suppliers to maximize the profit. Finally, we assessed the impact of return quality and quantity uncertainties, cost of remanufacture and inventory capacity at each site on the profits of the remanufacturer, considering a

multi-period production planning horizon.

- **The managerial implications for environmental friendly decision making of EOL products;**

The proposed model could be useful for operation managers to determine the best route for each returned product or disassembled part, and the appropriate quantity of parts purchased from external suppliers in order to maximize the profit. The numerical analysis showed that the minimum required acceptance quality is dependent on the capacity of sites' inventory level, varying cost parameters and the upper bound of disposal rate.

## 4.2 Suggestions for Future Work

There are some limitations for the proposed decision making models. In this section we list these limitations and possible extensions of the developed models.

- The proposed model in Chapter 2 assumes that the remanufacturing process follows an exponential distribution and is modeled as an  $M/M/1$  queue. This assumption can be changed to follow more general processing time distribution and priority policies. (Otieno, 2015) presented a remanufacturing simulation model for instances where process priority and labor is assigned to returned cores depending on their warranty status, this paper provides a realistic foundation upon which such a study extension can be based. Additionally, the model did not consider the acquisition price dependency on the quality of return, which would present a more realistic scenario. Another possible research extensions for this study could incorporate a multi-product, multi-period scenario as was studied for the problem in Chapter 3. Finally, a realistic situation should be modeled in which, before a product is routed for salvaging due to a full recoverable returns inventory, it is considered to replace a product with the lowest quality level in the inventory.
- The model presented in Chapter 3 can be extended to improve the proposed model

along the following lines: First, the current model assumes that all remanufactured products will be restored to the like-new condition. While this assumption simplifies the model, considering the efficiency rate of remanufacturing process would be more practical. Second, the model could be extended with other quality dependent variables like time to remanufacture and remanufacturing lead time.

Overall, in the current world of connected systems and artificial intelligence, the work in this dissertation could be used to develop an agile dynamic decision making system that automatically suggests optimal return quality thresholds, quantity of returns and parts to be purchased and recovery pathways that automatically and preemptively responds to the supply and demand forecast.



---

## BIBLIOGRAPHY

- Abbey, J. D., Kleber, R., Souza, G. C., Voigt, G., 2017. The role of perceived quality risk in pricing remanufactured products. *Production and Operations Management* 26 (1), 100–115.
- Abdulrahman, M. D.-A., Subramanian, N., Liu, C., Shu, C., 2015. Viability of remanufacturing practice: a strategic decision making framework for chinese auto-parts companies. *Journal of Cleaner Production* 105, 311–323.
- Agrawal, S., Singh, R. K., Murtaza, Q., 2015. A literature review and perspectives in reverse logistics. *Resources, Conservation and Recycling* 97, 76–92.
- Ahiska, S. S., Kurtul, E., 2014. Modeling and analysis of a product substitution strategy for a stochastic manufacturing/remanufacturing system. *Computers & Industrial Engineering* 72, 1–11.
- Ahluwalia, P. K., Nema, A. K., 2007. A life cycle based multi-objective optimization model for the management of computer waste. *Resources, Conservation and Recycling* 51 (4), 792–826.
- Akçalı, E., Cetinkaya, S., 2011. Quantitative models for inventory and production planning in closed-loop supply chains. *International Journal of Production Research* 49 (8), 2373–2407.
- Aras, N., Boyaci, T., Verter, V., 2004. The effect of categorizing returned products in remanufacturing. *IIE transactions* 36 (4), 319–331.
- Atasu, A., Souza, G. C., 2013. How does product recovery affect quality choice? *Production and Operations Management* 22 (4), 991–1010.
- Bakal, I. S., Akcali, E., 2006. Effects of random yield in remanufacturing with price-sensitive supply and demand. *Production and operations management* 15 (3), 407–420.

- Balakrishnan, A., Geunes, J., 2000. Requirements planning with substitutions: exploiting bill-of-materials flexibility in production planning. *Manufacturing & Service Operations Management* 2 (2), 166–185.
- Bayındır, Z. P., Erkip, N., Güllü, R., 2003. A model to evaluate inventory costs in a remanufacturing environment. *International Journal of Production Economics* 81, 597–607.
- Behdad, S., Kwak, M., Kim, H., Thurston, D., 2010. Simultaneous selective disassembly and end-of-life decision making for multiple products that share disassembly operations. *Journal of Mechanical Design* 132 (4), 041002.
- Behdad, S., Williams, A. S., Thurston, D., 2012. End-of-life decision making with uncertain product return quantity. *Journal of Mechanical Design* 134 (10), 100902.
- Behret, H., Korugan, A., 2009. Performance analysis of a hybrid system under quality impact of returns. *Computers & Industrial Engineering* 56 (2), 507–520.
- Bolch, G., Greiner, S., de Meer, H., Trivedi, K. S., 2006. *Queueing networks and Markov chains: modeling and performance evaluation with computer science applications*. John Wiley & Sons.
- Bufardi, A., Gheorghe, R., Kiritsis, D., Xirouchakis, P., 2004. Multicriteria decision-aid approach for product end-of-life alternative selection. *International Journal of Production Research* 42 (16), 3139–3157.
- Chan, J. W., 2008. Product end-of-life options selection: grey relational analysis approach. *International Journal of Production Research* 46 (11), 2889–2912.
- Chang, K.-H., Lu, Y.-S., 2008. Queueing analysis on a mto production system consisting of mts pre-production. In: *Networked Computing and Advanced Information Management, 2008. NCM'08. Fourth International Conference on*. Vol. 2. IEEE, pp. 615–620.

- Chang, K.-H., Lu, Y.-S., 2010. Queueing analysis on a single-station make-to-stock/make-to-order inventory-production system. *Applied Mathematical Modelling* 34 (4), 978–991.
- Ching, W., Yuen, W., Loh, A., 2003. An inventory model with returns and lateral transshipments. *Journal of the Operational Research Society* 54 (6), 636–641.
- Ching, W.-K., Li, T., Xue, J., 2007. On hybrid re-manufacturing systems: A matrix geometric approach. In: *Proceedings of the International Conference on Industrial Engineering and Systems Management* (available online at: <http://hkumath.hku.hk/imr/IMRPreprintSeries/2007/IMR2007-16.pdf>).
- Cho, S., Jun, H.-B., Kiritsis, D., 2017. Heuristic algorithms for maximising the total profit of end-of-life computer remanufacturing. *International Journal of Production Research* 55 (5), 1350–1367.
- Clegg, A. J., Williams, D. J., Uzsoy, R., 1995. Production planning for companies with remanufacturing capability. In: *Electronics and the Environment, 1995. ISEE., Proceedings of the 1995 IEEE International Symposium on. IEEE*, pp. 186–191.
- Das, K., Chowdhury, A. H., 2012. Designing a reverse logistics network for optimal collection, recovery and quality-based product-mix planning. *International Journal of Production Economics* 135 (1), 209–221.
- De Brito, M. P., Dekker, R., 2002. Reverse logistics-a framework. Tech. rep., Erasmus School of Economics (ESE).
- Dekker, R., Fleischmann, M., Inderfurth, K., van Wassenhove, L. N., 2013. *Reverse logistics: quantitative models for closed-loop supply chains*. Springer Science & Business Media.
- Denizel, M., Ferguson, M., et al., 2010. Multiperiod remanufacturing planning with uncertain quality of inputs. *IEEE Transactions on Engineering Management* 57 (3), 394–404.

- Dobos, I., Richter, K., 2004. An extended production/recycling model with stationary demand and return rates. *International Journal of Production Economics* 90 (3), 311–323.
- Dobos, I., Richter, K., 2006. A production/recycling model with quality consideration. *International Journal of Production Economics* 104 (2), 571–579.
- Du, Y., Cao, H., Liu, F., Li, C., Chen, X., 2012. An integrated method for evaluating the remanufacturability of used machine tool. *Journal of Cleaner Production* 20 (1), 82–91.
- El Saadany, A. M., Jaber, M. Y., 2010. A production/remanufacturing inventory model with price and quality dependant return rate. *Computers & Industrial Engineering* 58 (3), 352–362.
- EPA, 2008. Fact Sheet: Management of Electronic Waste in the United States. <http://nepis.epa.gov/Exe/ZyPURL.cgi?Dockey=P1000ZT5.TXT>, [Online; accessed 20-October-2017].
- Fathi, M., Zandi, F., Jouini, O., 2015. Modeling the merging capacity for two streams of product returns in remanufacturing systems. *Journal of Manufacturing Systems* 37, 265–276.
- Ferguson, M., Guide, V. D., Koca, E., Souza, G. C., 2009. The value of quality grading in remanufacturing. *Production and Operations Management* 18 (3), 300–314.
- Ferguson, M., Guide, V. D. R., Koca, E., Souza, G., 2006. Remanufacturing planning with different quality levels for product returns.
- Ferrer, G., 1997. The economics of personal computer remanufacturing. *Resources, Conservation and Recycling* 21 (2), 79–108.
- Ferrer, G., Whybark, D., 2003. The economics of remanufacture. In: Guide, V. D. R., Wassenhove, L. N. (Eds.), *Business aspects of closed-loop supply chains*. Carnegie Mellon University Press, Pittsburgh, PA, pp. 317–354.

- Flapper, S. D., Gayon, J.-P., Lim, L. L., 2014. On the optimal control of manufacturing and remanufacturing activities with a single shared server. *European Journal of Operational Research* 234 (1), 86–98.
- Fleischmann, M., Bloemhof-Ruwaard, J. M., Dekker, R., Van der Laan, E., Van Nunen, J. A., Van Wassenhove, L. N., 1997. Quantitative models for reverse logistics: A review. *European journal of operational research* 103 (1), 1–17.
- Fleischmann, M., Kuik, R., 2003. On optimal inventory control with independent stochastic item returns. *European Journal of Operational Research* 151 (1), 25–37.
- Franke, C., Basdere, B., Ciupek, M., Seliger, S., 2006. Remanufacturing of mobile phones capacity, program and facility adaptation planning. *Omega* 34 (6), 562–570.
- Galbreth, M. R., Blackburn, J. D., 2006. Optimal acquisition and sorting policies for remanufacturing. *Production and Operations Management* 15 (3), 384–392.
- Galbreth, M. R., Blackburn, J. D., 2010. Optimal acquisition quantities in remanufacturing with condition uncertainty. *Production and Operations Management* 19 (1), 61–69.
- Gallo, M., Guerra, L., Guizzi, G., 2009. Hybrid remanufacturing/manufacturing systems: Secondary markets issues and opportunities. *WSEAS Transactions on Business and Economics* 6 (1), 31–41.
- Geyer, R., Van Wassenhove, L. N., Atasu, A., 2007. The economics of remanufacturing under limited component durability and finite product life cycles. *Management science* 53 (1), 88–100.
- Giannetti, B. F., Bonilla, S. H., Almeida, C. M., 2013. An energy-based evaluation of a reverse logistics network for steel recycling. *Journal of cleaner Production* 46, 48–57.
- Giri, B., Sharma, S., 2015. Optimizing a closed-loop supply chain with manufacturing defects and quality dependent return rate. *Journal of Manufacturing Systems* 35, 92–111.

- Giri, B., Sharma, S., 2016. Optimal production policy for a closed-loop hybrid system with uncertain demand and return under supply disruption. *Journal of Cleaner Production* 112, 2015–2028.
- Golany, B., Yang, J., Yu, G., 2001. Economic lot-sizing with remanufacturing options. *International Transactions* 33 (11), 995–1003.
- Govindan, K., Popiuc, M. N., 2014. Reverse supply chain coordination by revenue sharing contract: A case for the personal computers industry. *European Journal of Operational Research* 233 (2), 326–336.
- Govindan, K., Soleimani, H., Kannan, D., 2015. Reverse logistics and closed-loop supply chain: A comprehensive review to explore the future. *European Journal of Operational Research* 240 (3), 603–626.
- Guide, V. D. R., 1999. *Production planning and control practices for remanufacturing*. APICS Educational & Research Foundation.
- Guide, V. D. R., 2000. Production planning and control for remanufacturing: industry practice and research needs. *Journal of operations Management* 18 (4), 467–483.
- Guide, V. D. R., Gunes, E. D., Souza, G. C., Van Wassenhove, L. N., 2008. The optimal disposition decision for product returns. *Operations Management Research* 1 (1), 6–14.
- Guide, V. D. R., Wassenhove, L. N., 2001. Managing product returns for remanufacturing. *Production and operations management* 10 (2), 142–155.
- Guide Jr, V. D. R., Teunter, R. H., Van Wassenhove, L. N., 2003. Matching demand and supply to maximize profits from remanufacturing. *Manufacturing & Service Operations Management* 5 (4), 303–316.
- Guide Jr, V. D. R., Van Wassenhove, L. N., 2009. On the evolution of closed-loop supply chain research. *Operations research* 57 (1), 10–18.

- Guo, J., Ya, G., 2015. Optimal strategies for manufacturing/remanufacturing system with the consideration of recycled products. *Computers & Industrial Engineering* 89, 226–234.
- Gupta, S., Veerakamolmal, P., 2001. Aggregate planning for end-of-life products. *Greener Manufacturing and Operations: From Design to Delivery and Back*. Greenleaf Publishing Ltd., Sheffield, UK, 205–222.
- Han, S., Ma, W., Zhao, L., Zhang, X., Lim, M. K., Yang, S., Leung, S., 2016. A robust optimisation model for hybrid remanufacturing and manufacturing systems under uncertain return quality and market demand. *International Journal of Production Research* 54 (17), 5056–5072.
- Harrison, J. M., 1975. Dynamic scheduling of a multiclass queue: Discount optimality. *Operations Research* 23 (2), 270–282.
- Hawks, K., 2006. What is reverse logistics? *Reverse logistics magazine* 1 (1).
- Hedayati, M., Subic, A., 2011. A framework for extended end-of-life vehicle (elv) recovery rate based on a sustainable treatment option. *International Journal of Sustainable Design* 1 (4), 381–401.
- Hein, R., Kleindorfer, P. R., Spinler, S., 2012. Remanufacturing with variable quality levels.
- Heyman, D. P., 1977. Optimal disposal policies for a single-item inventory system with returns. *Naval Research Logistics (NRL)* 24 (3), 385–405.
- Hsieh, A.-S., 2010. Analysis of drivers and barriers for personal computer re-use: A case study of secondary pcs in taiwan. *IIIEE Master thesis*.
- Ilgın, M. A., Gupta, S. M., 2010. Environmentally conscious manufacturing and product recovery (ecmpro): a review of the state of the art. *Journal of environmental management* 91 (3), 563–591.

- Ilgın, M. A., Gupta, S. M., 2012. Remanufacturing modeling and analysis. CRC Press.
- Inderfurth, K., de Kok, A. G., Flapper, S., 2001. Product recovery in stochastic remanufacturing systems with multiple reuse options. *European Journal of Operational Research* 133 (1), 130–152.
- Inderfurth, K., van der Laan, E., 2001. Leadtime effects and policy improvement for stochastic inventory control with remanufacturing. *International Journal of Production Economics* 71 (1), 381–390.
- Jayaraman, V., 2006. Production planning for closed-loop supply chains with product recovery and reuse: an analytical approach. *International Journal of Production Research* 44 (5), 981–998.
- Jewkes, E. M., Alfa, A. S., 2009. A queueing model of delayed product differentiation. *European Journal of Operational Research* 199 (3), 734–743.
- Jin, X., Ni, J., Hu, S. J., Xiao, G., Chang, Q., 2014. Threshold-type admission policy for remanufacturing systems. In: *Automation Science and Engineering (CASE), 2014 IEEE International Conference*. pp. 467–473.
- Jin, X., Ni, J., Koren, Y., 2011. Optimal control of reassembly with variable quality returns in a product remanufacturing system. *CIRP Annals-Manufacturing Technology* 60 (1), 25–28.
- Junior, M. L., Filho, M. G., 2012. Production planning and control for remanufacturing: literature review and analysis. *Production Planning & Control* 23 (6), 419–435.
- Kaebnick, H., Anityasari, M., Kara, S., 2002. A technical and economic model for end-of-life (eol) options of industrial products. *International Journal of Environment and Sustainable Development* 1 (2), 171–183.
- Kannan, D., Garg, K., Jha, P., Diabat, A., 2017. Integrating disassembly line balancing in the planning of a reverse logistics network from the perspective of a third party provider. *Annals of Operations Research* 253 (1), 353–376.



- Karaer, Ö., Lee, H. L., 2007. Managing the reverse channel with rfid-enabled negative demand information. *Production and Operations Management* 16 (5), 625–645.
- Karamouzian, A., Teimoury, E., Modarres, M., 2011. A model for admission control of returned products in a remanufacturing facility using queuing theory. *The International Journal of Advanced Manufacturing Technology* 54 (1), 403–412.
- Kiesmüller, G. P., Van der Laan, E. A., 2001. An inventory model with dependent product demands and returns. *International journal of production economics* 72 (1), 73–87.
- Kim, E., Saghafian, S., Van Oyen, M. P., 2013. Joint control of production, remanufacturing, and disposal activities in a hybrid manufacturing–remanufacturing system. *European Journal of Operational Research* 231 (2), 337–348.
- Kim, K., Song, I., Kim, J., Jeong, B., 2006. Supply planning model for remanufacturing system in reverse logistics environment. *Computers & Industrial Engineering* 51 (2), 279–287.
- Korugan, A., Dinguç, K. D., Önen, T., Ateş, N. Y., 2013. On the quality variation impact of returns in remanufacturing. *Computers & Industrial Engineering* 64 (4), 929–936.
- Kuehr, R., Velasquez, G. T., Williams, E., 2003. Computers and the environmentan introduction to understanding and managing their impacts. *Computers and the Environment: Understanding and Managing their Impacts*, 1–15.
- Kumar, R., Ramachandran, P., 2016. Revenue management in remanufacturing: perspectives, review of current literature and research directions. *International Journal of Production Research* 54 (7), 2185–2201.
- Latouche, G., Ramaswami, V., 1993. A logarithmic reduction algorithm for quasi-birth-death processes. *Journal of Applied Probability* 30 (3), 650–674.
- Latouche, G., Ramaswami, V., 1999. *Introduction to matrix analytic methods in stochastic modeling*. SIAM.

- Law, A. M., Kelton, W. D., Kelton, W. D., 1991. Simulation modeling and analysis. Vol. 2. McGraw-Hill New York.
- Lechner, G., Reimann, M., 2014. Impact of product acquisition on manufacturing and remanufacturing strategies. *Production & Manufacturing Research* 2 (1), 831–859.
- Li, X., Li, Y., Govindan, K., 2014. An incentive model for closed-loop supply chain under the epr law. *Journal of the Operational Research Society* 65 (1), 88–96.
- Li, Y., Chen, J., Cai, X., 2006. Uncapacitated production planning with multiple product types, returned product remanufacturing, and demand substitution. *OR Spectrum* 28 (1), 101–125.
- Mahadevan, B., Pyke, D. F., Fleischmann, M., 2003. Periodic review, push inventory policies for remanufacturing. *European Journal of Operational Research* 151 (3), 536–551.
- Mahapatra, S., Pal, R., Narasimhan, R., 2012. Hybrid (re) manufacturing: manufacturing and operational implications. *International Journal of Production Research* 50 (14), 3786–3808.
- Mashhadi, A. R., Esmailian, B., Behdad, S., 2015. Uncertainty management in remanufacturing decisions: a consideration of uncertainties in market demand, quantity, and quality of returns. *ASCE-ASME Journal of Risk and Uncertainty in Engineering Systems, Part B: Mechanical Engineering* 1 (2), 021007.
- Matsumoto, M., Yang, S., Martinsen, K., Kainuma, Y., 2016. Trends and research challenges in remanufacturing. *International journal of precision engineering and manufacturing-green technology* 3 (1), 129–142.
- Matthews, H. S., Matthews, D. H., 2003. Information technology products and the environment. *Computers and the environment: Understanding and Managing their impacts*, 17–39.

- Meini, B., 1998. Solving qbd problems: the cyclic reduction algorithm versus the invariant subspace method. *Advances in Performance Analysis* 1, 215–225.
- Misni, F., Lee, L. S., 2017. A review on strategic, tactical and operational decision planning in reverse logistics of green supply chain network design. *Journal of Computer and Communications* 5 (08), 83.
- Mitra, S., 2007. Revenue management for remanufactured products. *Omega* 35 (5), 553–562.
- Muckstadt, J. A., Isaac, M. H., 1981. An analysis of single item inventory systems with returns. *Naval Research Logistics (NRL)* 28 (2), 237–254.
- Mukhopadhyay, S. K., Ma, H., 2009. Joint procurement and production decisions in remanufacturing under quality and demand uncertainty. *International Journal of Production Economics* 120 (1), 5–17.
- Nenes, G., Nikolaidis, Y., 2012. A multi-period model for managing used product returns. *International Journal of Production Research* 50 (5), 1360–1376.
- Neuts, M. F., 1981. Matrix-geometric solutions in stochastic models: an algorithmic approach. Courier Corporation.
- Niknejad, A., Petrovic, D., 2014. Optimisation of integrated reverse logistics networks with different product recovery routes. *European Journal of Operational Research* 238 (1), 143–154.
- Nikolaidis, Y., 2009. A modelling framework for the acquisition and remanufacturing of used products. *International Journal of Sustainable Engineering* 2 (3), 154–170.
- Nikolaidis, Y., 2013. Reverse logistics and quality management issues: State-of-the-art. In: *Quality Management in Reverse Logistics*. Springer, pp. 1–19.
- Omwando, T. A., Otieno, W. A., Farahani, S., Ross, A. D., 2018. A bi-level fuzzy analytical decision support tool for assessing product remanufacturability. *Journal of Cleaner Production* 174, 1534–1549.

- Otieno, W., 2015. Labor capacity assignment model for remanufacturing environments. In: International Conference on Remanufacturing (ICoR2015. Amsterdam, Netherlands). pp. 235–246.
- Pasandideh, S. H. R., Niaki, S. T. A., Maleki, L., 2015. A bi-objective remanufacturing problem within queuing framework: An imperialist competitive algorithm. International Journal of Management Science and Engineering Management 10 (3), 199–209.
- Pohlen, T. L., Theodore Farris, M., 1992. Reverse logistics in plastics recycling. International Journal of Physical Distribution & Logistics Management 22 (7), 35–47.
- Pokharel, S., Mutha, A., 2009. Perspectives in reverse logistics: a review. Resources, Conservation and Recycling 53 (4), 175–182.
- Radhi, M., Zhang, G., 2016. Optimal configuration of remanufacturing supply network with return quality decision. International Journal of Production Research 54 (5), 1487–1502.
- Rapp, D., 2016. How can you get low-cost (or no-cost) computers for your district? URL <http://www.scholastic.com/browse/article.jsp?id=3751246>
- Richter, K., Sombrutzki, M., 2000. Remanufacturing planning for the reverse wagner/whitin models. European Journal of Operational Research 121 (2), 304–315.
- Robotis, A., Boyaci, T., Verter, V., 2012. Investing in reusability of products of uncertain remanufacturing cost: the role of inspection capabilities. International Journal of Production Economics 140 (1), 385–395.
- Rubio, S., Chamorro, A., Miranda, F. J., 2008. Characteristics of the research on reverse logistics (1995–2005). International journal of production research 46 (4), 1099–1120.
- Sahni, S., Boustani, A., Gutowski, T., Graves, S., 2010. Personal computer remanufacturing and energy savings. Tech. rep., Technical Report, MIT Energy Initiative Report Series.

- Shi, J., Zhang, G., Sha, J., 2011. Optimal production planning for a multi-product closed loop system with uncertain demand and return. *Computers & Operations Research* 38 (3), 641–650.
- Song, J.-S., Xu, S. H., Liu, B., 1999. Order-fulfillment performance measures in an assemble-to-order system with stochastic leadtimes. *Operations Research* 47 (1), 131–149.
- Souza, G. C., Ketzenberg, M. E., Guide, V. D. R., 2002. Capacitated remanufacturing with service level constraints. *Production and operations management* 11 (2), 231–248.
- Srivastava, S. K., 2007. Green supply-chain management: a state-of-the-art literature review. *International journal of management reviews* 9 (1), 53–80.
- Steubing, B., Böni, H., Schluep, M., Silva, U., Ludwig, C., 2010. Assessing computer waste generation in chile using material flow analysis. *Waste Management* 30 (3), 473–482.
- Stock, J. R., 1992. Reverse logistics: White paper. Council of Logistics Management.
- Takahashi, K., Morikawa, K., Takeda, D., Mizuno, A., et al., 2007. Inventory control for a markovian remanufacturing system with stochastic decomposition process. *International Journal of Production Economics* 108 (1), 416–425.
- Teunter, R. H., 2006. Determining optimal disassembly and recovery strategies. *Omega* 34 (6), 533–537.
- Teunter, R. H., Flapper, S. D. P., 2011. Optimal core acquisition and remanufacturing policies under uncertain core quality fractions. *European Journal of Operational Research* 210 (2), 241–248.
- Thierry, M., Salomon, M., Van Nunen, J., Van Wassenhove, L., 1995. Strategic issues in product recovery management. *California management review* 37 (2), 114–135.
- Tibben-Lembke, R., Rogers, D., 1998. Going backwards: reverse logistics trends and practices. Reverse Logistics Executive Council.

- Toktay, L. B., Wein, L. M., Zenios, S. A., 2000. Inventory management of remanufacturable products. *Management science* 46 (11), 1412–1426.
- Trebilcock, B., 2002. A winning formula for reverse logistics. *Modern Materials Handling* 57 (10), 37–39.
- Van der Laan, E., Dekker, R., Salomon, M., 1996. Product remanufacturing and disposal: A numerical comparison of alternative control strategies. *International Journal of Production Economics* 45 (1-3), 489–498.
- Van Der Laan, E., Salomon, M., Dekker, R., Van Wassenhove, L., 1999. Inventory control in hybrid systems with remanufacturing. *Management science* 45 (5), 733–747.
- Van der Laan, E. A., Teunter, R. H., 2006. Simple heuristics for push and pull remanufacturing policies. *European Journal of Operational Research* 175 (2), 1084–1102.
- Van Leeuwaarden, J., Winands, E., 2006. Quasi-birth-and-death processes with an explicit rate matrix. *Stochastic models* 22 (1), 77–98.
- Van Wassenhove, L. N., Zikopoulos, C., 2010. On the effect of quality overestimation in remanufacturing. *International Journal of Production Research* 48 (18), 5263–5280.
- Vanian, J., Jan 2017. Lenovo, hp, and dell lead the shrinking pc market.  
URL <http://fortune.com/2017/01/11/lenovo-hp-dell-pc-market/>
- Vercraene, S., Gayon, J.-P., 2013. Optimal control of a production-inventory system with product returns. *International Journal of Production Economics* 142 (2), 302–310.
- Watanabe, T., Kusuawa, E., Arizono, I., 2013. Optimal operation for green supply chain in consideration of collection incentive and quality for recycling of used products. *Industrial Engineering and Management Systems* 12 (4), 317–329.
- Wei, S., Tang, O., Liu, W., 2015. Refund policies for cores with quality variation in oem remanufacturing. *International Journal of Production Economics* 170, 629–640.

- Williams, E. D., Sasaki, Y., 2003. Energy analysis of end-of-life options for personal computers: resell, upgrade, recycle. In: Electronics and the Environment, 2003. IEEE International Symposium on. IEEE, pp. 187–192.
- Zerhouni, H., Gayon, J.-P., Frein, Y., 2013. Influence of dependency between demands and returns in a reverse logistics system. International Journal of Production Economics 143 (1), 62–71.
- Zhou, S. X., Tao, Z., Chao, X., 2011. Optimal control of inventory systems with multiple types of remanufacturable products. Manufacturing & Service Operations Management 13 (1), 20–34.
- Zikopoulos, C., Tagaras, G., 2007. Impact of uncertainty in the quality of returns on the profitability of a single-period refurbishing operation. European Journal of Operational Research 182 (1), 205–225.
- Zikopoulos, C., Tagaras, G., 2008. On the attractiveness of sorting before disassembly in remanufacturing. IIE Transactions 40 (3), 313–323.

---

## Curriculum Vitae



# SAJJAD FARAHANI

Department of Industrial Engineering  
University of Wisconsin-Milwaukee  
3200 North Cramer Street, Milwaukee, WI 53211

## EDUCATION

---

- University of Wisconsin-Milwaukee** *September 2013 - May 2018*  
Ph.D. in Industrial Engineering (Minor: Business - Supply Chain Management) Overall GPA: 3.82/4  
*Dissertation:* Optimal decision making for capacitated reverse logistics networks with quality variation  
*Committee:* Wilkistar Otieno, Brett Peters, Hamid Seifoddini, Xiaohang Yue, Hossein Hosseini
- University of Wisconsin-Milwaukee** *September 2013 - May 2015*  
M.Sc. in Industrial Engineering (Minor: Business - Supply Chain Management) Overall GPA: 3.8/4
- Amirkabir University of Technology** *September 2011 - May 2013*  
M.Sc. in Industrial Engineering (Minor: Logistics) Overall GPA: 3.9/4  
*Thesis:* A bi-criteria cross docking just-in-time scheduling considering preemption and customer demand
- Amirkabir University of Technology** *September 2005 - September 2010*  
B.Sc. in Industrial Engineering Overall GPA: 3.7/4

## TEACHING INTERESTS

---

Supply Chain Management, Operations Management, Statistics, Managerial Decision Making, Facility Layout and Material Handling.

## RESEARCH INTERESTS

---

Supply Chain Sustainability, Reverse Logistics.

## PUBLICATIONS

---

### Journal Publications

- Omwando, T. A., Otieno, W. A., **Farahani, S.**, Ross, A. D. (2018). A Bi-Level fuzzy analytical decision support tool for assessing product remanufacturability. *Journal of Cleaner Production*, 174, 1534-1549.
- Rezazadeh, M. and **Farahani, S.** (2010). A multi-objective approach for multi capacity warehouse location within distribution supply chain problem. *Journal of American Science*.

### Manuscript Under Review

- **Farahani, S.**, Otieno, W. A., Barah, M. Environmentally Friendly Disposition Decisions for End-Of-Life Electrical and Electronic Products: The Case of Computer Remanufacture
- **Farahani, S.**, Otieno, W., Omwando, T. The Optimal Disposition Policy for Remanufacturing Systems With Variable Quality Returns (A Case Study)

### Books

- **Farahani, S.**, 2011. Concise description of operation research for engineering students, Arshad Publications, ISBN: 978-600-115-016-6 (in Persian).
- **Farahani, S.**, 2011. Concise description of facility layout for engineering students, Arshad Publications, ISBN: 978-600-115-015-9 (in Persian).

- **Farahani, S.**, 2012. Facility layout: concise review of last decade entrance exams, Arshad Publications, ISBN: 978-600-115-079-1 (in Persian).

## CONFERENCE PRESENTATIONS

---

- **Farahani, S.**, Otieno, W.A. , Production planning of a remanufacturing system with quality variation in reverse logistics environment. 2017 INFORMS Annual Meeting, Houston, TX.
- **Farahani, S.**, Otieno, W.A., Yue, X., On the optimal control of remanufacturing activities with quality variation of returns. 2016 INFORMS Annual Meeting, Nashville, TN.
- **Farahani, S.**, Otieno, W.A., Optimum policy in hybrid (re)manufacturing system of short life cycle products. 2015 INFORMS Annual Meeting, Philadelphia, PA.
- **Farahani, S.**, Zandi, F., Optimal Inventory Policy and Disposition Decision for a Supply Chain with Stochastic Returned Products. 2014 INFORMS Annual Meeting, San Francisco, CA.

## PROFESSIONAL EXPERIENCE

---

### Academic

- |   |  |
|---|--|
| <b>Instructor / Graduate Teaching Assistant</b><br><i>University of Wisconsin-Milwaukee</i> | <i>September 2013 - January 2018</i><br><i>Milwaukee, WI</i> |
| <b>Graduate Research Assistant</b><br><i>Amirkabir University of Technology</i>             | <i>September 2012 - July 2013</i><br><i>Tehran, Iran</i>     |

### Industry

- |  |  |
|--|--|
| <b>AVP - Risk Management</b><br><i>Ascentium Capital</i>                               | <i>February 2018 - Present</i><br><i>Denver, CO</i>        |
| <b>Intern, Data Analytics</b><br><i>Ascentium Capital</i>                              | <i>June 2017 - August 2017</i><br><i>Denver, CO</i>        |
| <b>Intern, Data Analytics</b><br><i>Healthgrades</i>                                   | <i>May 2016 - April 2017</i><br><i>Madison, WI</i>         |
| <b>Project Manager</b><br><i>Monenco Consulting Engineers Co., Planning Department</i> | <i>September 2010 - August 2013</i><br><i>Tehran, Iran</i> |

## TEACHING EXPERIENCE

---

### **Instructor**

- |   |                  |
|---|------------------|
| · Facility Layout and Material Handling (IND 583) | <i>Fall 2017</i> |
| · Engineering Economic Analysis (IND 360)         | <i>Fall 2016</i> |

### **Teaching Assistant**

- |   |                                 |
|---|---------------------------------|
| · Engineering Economic Analysis (IND 360)         | <i>Spring 2017</i>              |
| · Design of Experiment (IND 572)                  | <i>Spring 2014, Spring 2016</i> |
| · Facility Layout and Material Handling (IND 583) | <i>Fall 2015</i>                |
| · Introduction to Operations Analysis (IND 370)   | <i>Fall 2014</i>                |
| · Statistics (IND 463)                            | <i>Spring and Fall 2014</i>     |
| · Introduction to Engineering (IND 111)           | <i>Fall 2013</i>                |

## TECHNICAL SKILLS

---

<b>Programming</b>	C, MATLAB, Python
<b>Statistical Analysis</b>	R, Minitab, SPSS
<b>Database and Data Visualization</b>	SQL, Tableau, SQL Server R Services
<b>Optimization</b>	GAMS, LINGO
<b>Project Management</b>	MSP, Primavera Enterprise
<b>Other</b>	Experience in Linux command-line tools, bash scripting

## HONAR & AWARDS

---

<b>INFORMS Professional Colloquium(IPC) Award</b>	<i>April 2017</i>
\$700 awarded to attend IPC at INFORMS Conference on Business Analytics and Operations Research, Las Vegas, NV.	
<b>MMH Council Honor Scholarship</b>	<i>February 2016</i>
\$1,500 awarded by Material Handling Education Foundation.	
<b>Chancellors Graduate Student Award</b>	<i>three times between 2013-2017</i>
\$6,500 awarded by Industrial Engineering Department.	
<b>UW-Milwaukee travel fellowship award</b>	<i>Four times between 2014-2017</i>
Awarded to support the participation to INFORMS Annual Meeting and INFORMS conferences on Business Analytics & Operations Research	
<b>Ranked Among Top 10% of undergraduate Students</b>	<i>September 2013</i>
Directly admitted to Graduate Program in Industrial Engineering Department at Amirkabir university of technology by Exceptional Talents Organization	
<b>Amirkabir University of Technology Award</b>	<i>February 2007</i>

## PROFESSIONAL ACTIVITIES AND SERVICES

---

### Membership

INFORMS, INFORMS Professional Colloquium (IPC) ,MSOM Sustainable Operations, MSOM Service Management, MSOM Supply Chain Management.

### Services

**INFORMS - UWM student chapter:** Treasurer (2013-2017)

**Session Chair:** Retail Management, 2017 INFORMS Annual Meeting, Houston, TX.

**Reviewer for the following journal:** Journal of Engineering Manufacture